



User's Manual

A Pentium 4 Processor based AGP
(4X) mainboard (100/133MHz)

Supports PC1600/PC2100 Memory
Modules (DDR Memory)

TRADEMARK

All products and company names are trademarks or registered trademarks of their respective holders.

These specifications are subject to change without notice.

*Manual Revision 1.2
January 30, 2002*

Frequently Asked Questions For POST Port Only

The Below is the list of some basic POST Codes and their possible problems and solutions. For more detail information about POST Codes, please refer to Appendix E on this manual.

POST CODE	Problem	Solution
FFh or CFh	1.BIOS chip replace inverse 2.Update wrong BIOS 3.Mainboard problem 4.ADD-ON Card insert inappropriate	1.Make sure BIOS chip replace appropriate 2.Make sure all Hardware Device insert appropriate 3.Swap mainboard
C1h – C5h E1h – EEh A1h – A7h	1.Memory insert inappropriate 2.Memory compability problem 3.Memory Bad 4.SPD Data incorrect	1.Make sure insert Memory appropriate 2.Swap Memory
2Dh	1.Error occurs in VGA BIOS 2.VGA Card insert inappropriate	1.Swap VGA Card 2.Make sure insert VGA Card appropriate
26h	1.Over clock fail	1. Clear CMOS or press insert key to power on
07h – 12h	1.Init Keyboard Controller 2.RTC	1. Make sure insert K/B & Mouse appropriate 2.Swap Battery

Table of Contents

	<i>Page</i>
<i>Section 1</i>	<i>Introduction</i>
	Components Checklist 1-1
	<i>Overview</i>
	System Overview 1-2
	Chipset Components 1-3
	Intel Pentium 4 Processors 1-4
	Accelerated Graphics Port 1-5
	Ultra ATA66/100 1-5
	Hardware Monitoring 1-6
	Bandwidth Overview 1-6
	Mainboard Form-Factor 1-7
	I/O Shield Connector 1-8
	Power-On/Off (Remote) 1-8
	System Block Diagram 1-9
<i>Section 2</i>	<i>Features</i>
	Mainboard Features 2-1
<i>Section 3</i>	<i>Installation</i>
	Mainboard Detailed Layout 3-2
	<i>Easy Installation Procedure</i>
	CPU Installation 3-3
	Jumper Settings 3-5
	System Memory Configuration 3-6
	Device Connectors 3-8
	External Modem Ring-in Power ON and Keyboard Power ON Function (KBPO) 3-13
	STR Function 3-15
	845 Platform AGP Card 3.3V Protection 3-17

Section 4***Award BIOS Setup***

Main Menu	4-1
Standard CMOS Setup	4-3
Advanced BIOS Features	4-7
Advanced Chipset Features	4-10
Integrated Peripherals	4-13
Power Management Setup	4-19
PNP/PCI Configuration Setup	4-23
PC Health Status	4-25
Frequency/Voltage Control	4-27
Defaults Menu	4-29
Supervisor/User Password Setting	4-30
Exit Selecting	4-31

Section 5***Driver Installation***

845 and Sound Driver Installation	5-1
---	-----

Appendix***Appendix A***

Avance Media Player User's Guide	A-1
--	-----

Appendix B

GHOST 5.1/6.03 Quick User's Guide	B-1
---	-----

Appendix C

EEPROM BOIS Remover	C-1
---------------------------	-----

Appendix D

Update Your System BIOS	D-1
-------------------------------	-----

Appendix E

Post Codes	E-1
------------------	-----

Section 1
INTRODUCTION

Components Checklist

Package Contents

Optional Item

- | | |
|---|--|
| <input checked="" type="checkbox"/> A. (1) Mainboard | <input type="checkbox"/> F. (1) ATA-33 Hard drive ribbon cable |
| <input checked="" type="checkbox"/> B. (1) User's manual | <input type="checkbox"/> G. (1) USB Cable |
| <input checked="" type="checkbox"/> C. (1) Floppy ribbon cable | <input type="checkbox"/> H. (1) Driver Image + Partition Magic Tools |
| <input checked="" type="checkbox"/> D. (1) ATA-66/100 Hard drive ribbon cable | |
| <input checked="" type="checkbox"/> E. (1) Driver and utility | |

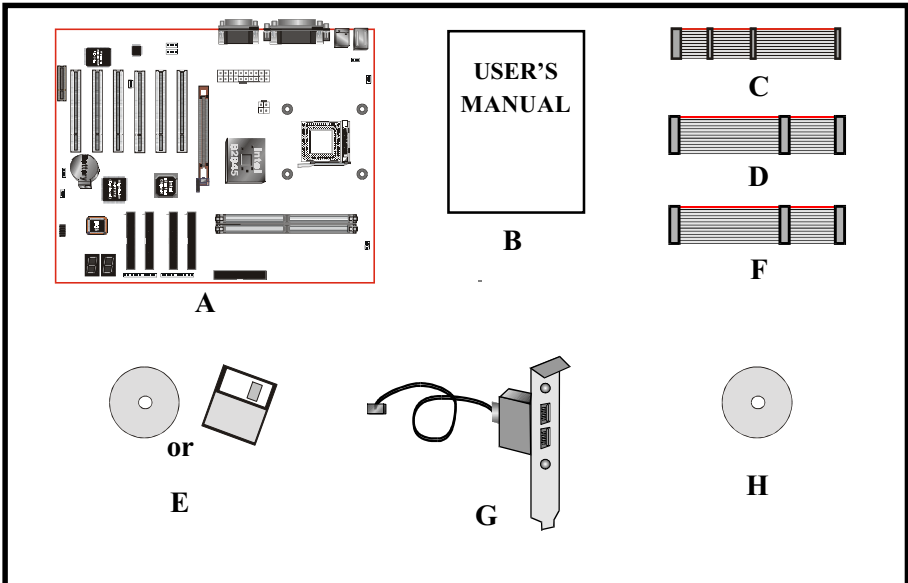

Introduction

System Overview

This board is designed with Intel® 845 chipset. The Intel® 845 chipset includes MCH(FW82845), ICH2(FW82801BA) and FWH three chips. The Intel® 845 chipset is the generation desktop chipset designed for Intel's FC-PGA2 socket 478 package architecture and support the 4X capability of the AGP 2.0 Interface Specification. A new chipset component interconnect, the hub interface, is designed into the Intel® 845 chipset to provide more efficient communication between chipset components.

Support of AGP 4X, 266MHz DDR SDRAM and the hub interface provides a balanced system architecture for the Pentium® 4 in the Socket 478 architecture processor minimizing bottlenecks and increasing system performance. By increasing memory bandwidth to 2.128GB/s through the use of AGP 4X, the Intel® 845 chipset will deliver the data throughput necessary to take advantage of the high performance provided by the powerful Pentium® 4 in the Socket 478 architecture processor.

The Intel® 845 chipset architecture removes the requirement for the ISA expansion bus that was traditionally integrated into the I/O subsystem of Intel chipsets. This removes many of the conflicts experienced when installing hardware and drivers into legacy ISA systems. The elimination of ISA will provide true plug-and-play for the Intel® 845 platform.

Intel® 845 chipset contains three core components: the Memory Controller Hub (MCH), the I/O Controller Hub (ICH) and the Firmware Hub (FWH). The MCH integrates the data transfer rate of 400/533MHz, Pentium® 4 processor bus controller, AGP 2.0 controller, 266MHz DDR SDRAM controller and a high-speed hub interface for communication with the ICH2. The ICH2 integrates an UltraATA/66/100 controller, USB host controller, LPC interface controller, FWH interface controller, PCI interface controller, and a hub interface for communication with the MCH. The Intel® 845 chipset will provide the data buffering and interface arbitration required to ensure that system interfaces operate efficiently and provide the system bandwidth necessary to obtain peak performance the Pentium® 4 in the Socket 478 architecture.

Chipset Components

The Intel® 845 chipset consists of the Memory Controller Hub (MCH), the I/O Controller Hub (ICH2) and the Firmware Hub (FWH).

◆ **Memory Controller Hub (MCH)**

The MCH provides the interconnect between the DDR SDRAM and the system logic. It integrates:

- Support for single processor with a data transfer rate of 400/533MHz.
- 200/266MHz DDR SDRAM interface supporting 2GB of DDR SDRAM.
- 2X, 4X, 1.5V AGP interface (Only support 1.5V on AGP interface).
- Downstream hub link for access to the ICH2.

◆ **I/O Controller Hub (ICH2)**

The I/O controller Hub provides the I/O subsystem with access to the rest of the system. Additionally, it integrates many I/O functions. The ICH integrates:

- Upstream hub link for access to the MCH
- 2 Channel Ultra ATA/33/66/100 Bus Master IDE controller
- USB controller
- SMBus controller
- FWH interface
- LPC interface
- PCI 2.2 interface
- Integrated System Management Controller
- Integrated LAN Controller

◆ **Firmware Hub (FWH)**

The FWH component is a key element to enabling a new security and manageability infrastructure for the PC platform. The device operates under the FWH interface and protocol. The hardware features of this device include a unique Random Number Generator (RNG), register-based locking, and hardware-based locking.

Introduction

Intel Pentium 4 processors

Formally known as the Willamette, the Pentium™ 4 is the next generation IA-32 processor from Intel. This next generation design is based upon a new micro-architecture that brings higher clock speeds and performance than previous processors could deliver. Among other advanced features the Pentium 4 offers Streaming SIMD extensions 2, Advanced Dynamic Execution, Hyper Pipelined Technology, and a data transfer rate of 400/533MHz system bus.

Streaming SIMD Extensions 2

Building upon the foundations of core features of their previous line of processors the Pentium III, this new version introduces Streaming SIMD Extensions 2 technology commonly referred to as SSE2. But what does this mean? SIMD stands for Single Instruction Multiple Data. Usually, processors process one data element in one instruction, called Single Instruction Single Data, or SISD. In contrast, with Single Instruction Single Data (SISD), SIMD has the ability to process more than one piece of data element during one instruction.

This technology is useful for 3D graphics applications that handle considerable amounts of floating-point numbers. With SIMD applications such as 3D graphics will be able to processor more data per instruction when equates to better performance. This technology adds 144 new instructions to the CPU core that can be used in a wide variety of applications. Software programmers can for example, take advantage of these new instructions and write more optimized code that take advantage of newer SIMD double-precision floating-point, integer, and cache ability instructions. In theory this will enable better next generation services such as Interactive Digital TV to be produced.

Advanced Dynamic Execution

Advanced Dynamic Execution describes the improved implementation and abilities over the older P6 processor line's out-of-order decoupled super scalar execution. Dynamic execution allows instructions to the processor to be executed without the need to do so in order. The ability to do this can add a significant performance increase versus ordered execution.

Hyper Pipelined Technology & 400/533MHz System Bus

Hyper Pipelined Technology doubles the pipeline depth the Pentium 4 delivers to 20 stages. This significantly increases the performance and frequency capabilities. Pentium 4 also introduces a 400/533MHz system bus as opposed to the 100 and

133MHz bus seen in previous Pentium III processors. This allows 3.2Gbytes per second of throughput while the Pentium III had a limited 1.06Gbyte/s throughput. Willamette will reportedly be introduced in the 0.18-micron using aluminum.

For more information about all the cool new features the Pentium 4 delivers check out the Intel website at <http://www.intel.com>

Accelerated Graphics Port (AGP or A.G.P.)

Typically, 3D graphics rendering requires a tremendous amount of memory, and demands ever increasing throughput speed as well. As 3D products for the personal computer become more and more popular, these demands will only increase. This will cause a rise in costs for both end users and manufacturers. Lowering these costs as well as improving performance is the primary motivation behind AGP. By providing a massive increase in the bandwidth available between the video card and the processor, it will assist in relieving some of these pressures for quite sometime.

The board provides the AGP 2.0 interface. The AGP Interface Specification revision 2.0 enhances the functionality of the original AGP Interface Specification (revision 1.0) by allowing 4X data transfers (4 data samples per clock) and 1.5 volt (power supply) operation. The AGP 2.0 interface, along with SDRAM memory technology, allows graphics controllers to access main memory at over 1GB/s. In order to match the 2X and 4X AGP Card. The board used the Universal AGP connector. (1.5 volt AGP Card supports only).

Ultra ATA/66/100

The ICH2 provides two channel Ultra ATA/66/100 Bus Master IDE controllers, that support Ultra ATA/66/100 protocols, perfect for such demanding applications as real-time video, multimedia, and high performance operating system. A new IDE cable is required for Ultra ATA/66/100. This cable is an 80 conductor cable; however the connectors are, of course, backwards compatible with ATA/33.

Introduction

Hardware Monitoring

Hardware monitoring allows you to monitor various aspects of your systems operations and status. The features include CPU temperature, voltage and RPM of fan.

Bandwidth Overview

Table 1 provides a summary of the bandwidth requirements for the Intel® 845 chipset.

Interface	Clock Speed (MHz)	Samples Per Clock	Data Rate (Mega-samples/s)	Data Width (Bytes)	Bandwidth (MB/s)
CPU Bus	100/133	4	400/533	8	3200/4264
DDR SDRAM	100/133	2	200/266	8	1600/2128
AGP 2.0	66.6	4	266	4	1066
Hub Link	66.6	4	266	1	266
PCI 2.2	33.3	1	33.3	4	133

Table 1: Intel® 845 platform Bandwidth Summary

Mainboard Form-Factor

The board is designed with ATX form factor - the latest industry standard of chassis. The ATX form factor is essentially a Baby-AT baseboard rotated 90 degrees within the chassis enclosure and a new mounting configuration for the power supply. With these changes the processor is relocated away from the expansion slots, allowing them all to hold full length add-in cards. ATX defines a double height aperture to the rear of the chassis which can be used to host a wide range of onboard I/O. Only the size and position of this aperture is defined, allowing PC manufacturers to add new I/O features (e.g.; TV input, TV output, joystick, modem, LAN, audio, etc.) to systems. This will help systems integrators differentiate their products in the marketplace, and better meet your needs.

- By integrating more I/O down onto the board and better positioning the hard drive and floppy connectors material cost of cables and add-in cards is reduced.
- By reducing the number of cables and components in the system, manufacturing time and inventory holding costs are reduced and reliability will increase.
- By using an optimized power supply, it's possible to reduce cooling costs and lower acoustical noise. An ATX or ATX12V power supply, which has a side-mounted fan, allows direct cooling of the processor and add-in cards making a secondary fan or active heatsink unnecessary in most system applications.

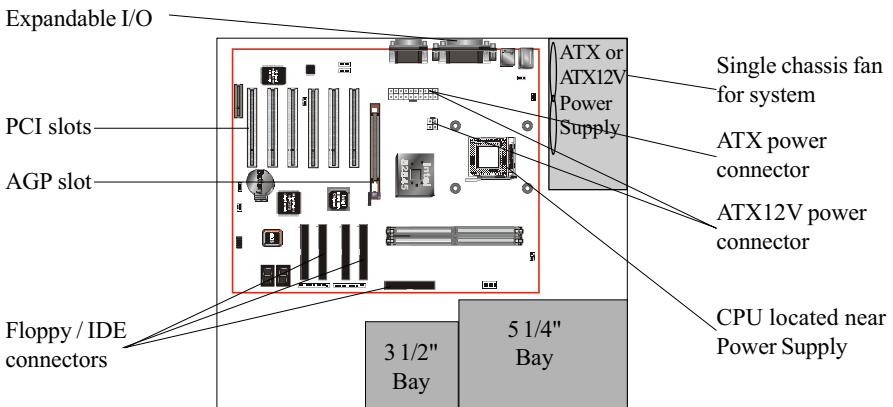

Figure 2: Summary of ATX or ATX12V chassis features

Introduction

I/O Shield Connector

The board is equipped with an I/O back panel. Please use the appropriate I/O shield (figure 3).

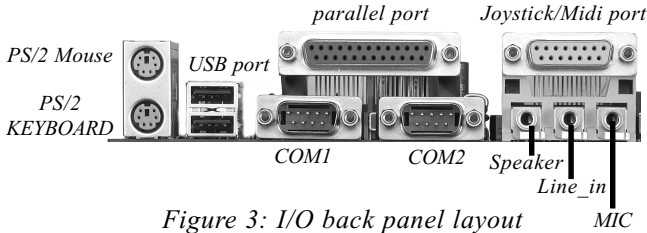

Figure 3: I/O back panel layout

Power-On/Off (Remote)

The board has a single 20-pin and 4-pin connector for ATX or ATX12V power supplies. For ATX or ATX12V power supplies that support the **Remote On/Off** feature, this should be connected to the systems front panel for system Power On/Off button. The systems power On/Off button should be a momentary button that is normally open.

The board has been designed with "Soft Off" functions. You can turn Off the system from one of two sources: The first is the front panel Power On/Off button, and the other is the "Soft Off" function (coming from the BOARD's onboard circuit controller) that can be controlled by the operating system such as Windows® 95/98 and Windows® 2000 to Shutdown the system.

Note: For maintaining the DDR SDRAM power during STR (ACPI S3) function, it is strongly recommend to use ATX or ATX12V power supplies that have a +5VSB current of (\geq) 1A (1000mA). Please check the 5VSB's specification that has been printed on the ATX or ATX12V power supply's outer case.

Note: The board requires a minimum of 250 Watt ATX or ATX 12V power supply to operate. Your system configuration (amount of memory, add-in cards, peripherals, etc.) may exceed the minimum power requirement but to ensure that adequate power is provided, use a 300 Watt (or greater) ATX or ATX 12V power supply.

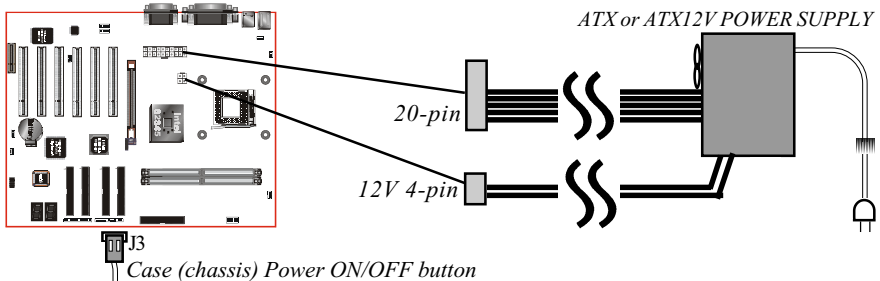

Figure 4: Simple ATX or ATX12V Power ON/OFF Controller

System Block Diagram

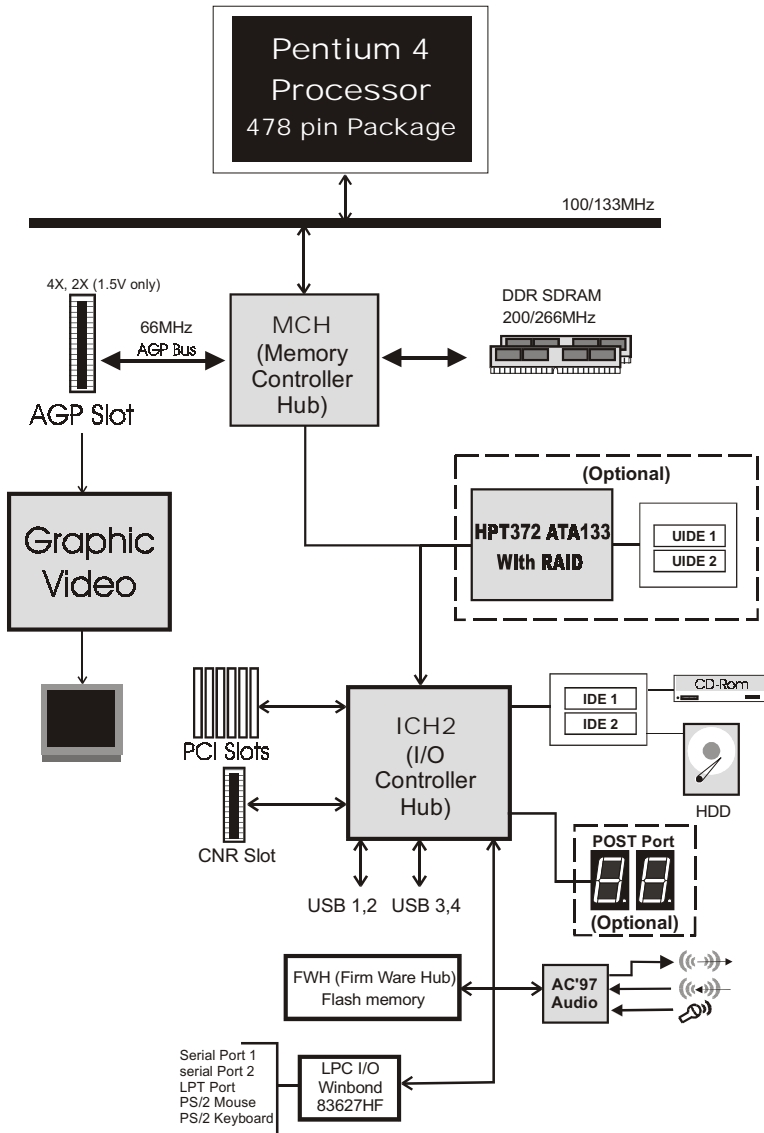

Figure 5: System Block Diagram

Mainboard Features:

◆ **PROCESSOR**

- Intel® Pentium 4 Processor with FC-PGA2 socket 478 package: Operating at 1.5 ~ 2.2GHz

◆ **CHIPSET**

- Intel 82845 AGPset

◆ **Front Side Bus**

- 100/133MHz (a data transfer rate of 400/533MHz)

◆ **DRAM MODULE**

- 184pin DDR DIMM x 2 for PC1600/2100 Memory
- DRAM Size: 64MB to 2GB

◆ **EXPANSION SLOT**

- PCI x 6, 4X AGP x 1 (1.5V only)
- CNR slot x 1 (Shared) for communication and network riser card

◆ **ONBOARD I/O**

- Winbond 83627HF-AW LPC I/O integrated with K/B , Mouse, FDD, Parallel and Serial, Fast IR and Power-ON controllers

◆ **ONBOARD PCI / IDE**

- Intel 82801BA/ICH2 Controller
- PCI Rev. 2.2 Compliant
 - ACPI Compliant Power Management

Features

- AC97 2.1/2.0 Compliant Link for Audio CODEC
- CNR supports multi-channel audio, V.90 analog modem, Home PNA, 10/100 LAN
- PCI Bus IDE Port with PIO /**Ultra DMA-66/100** x 2 (Up to 4 Devices)
- Extra IDE Port by HPT372 with **Ultra DMA-66/100/133** and IDE RAID x 2 (Up to 4 Devices) (**Optional**)

◆ I/O CONNECTOR

- PS/2 Mouse and PS/2 style Keyboard
- COM1, COM2, Printer, Audio-in/out, MIC & Game port connector

◆ USB

- USB connector x 4 (2 for Opt.)

◆ Built-in AC97 Digital Audio

- Dual full-duplex Direct Sound channels
- FM synthesis for legacy compatibility
- Supports Game and MIDI port

◆ BIOS

- Award Plug & Play BIOS

◆ EXTENDED FUNCTION

- Supports Hardware Monitoring Function by W83627HF-AW
- Supports exclusive KBPO (Keyboard Power ON) Function
- Supports STR (Suspend To RAM) power saving Function
- Supports STR Wake up function by USB Mouse & Keyboard device
- Supports Wake-On-LAN Function
- Supports CPU Vcore, AGP Vcore Settings via BIOS
- Supports CPU Ratio and Clock Settings via BIOS
- Supports Memory Vcore Voltage Settings via Jumper

- Supports Magic Health and Easy Boot Function
- Supports Asynchronous Transfer Mode between PCI & FSB
- POST Port onboard design with 7-segment LED display (**Optional**)
- Supports automatically shut down (to remove power) circuit when the processor (Silicon) has reached the temperature of approximately 135°C
- Supports automatically shut down to protect MCH(82845) damaging when is inadvertently used the 3.3V AGP Card plug in the AGP slot.
(See the Page 3-18 for detail)

◆ FORM FACTOR

- 305mm x 245mm ATX Size

Section 3
INSTALLATION

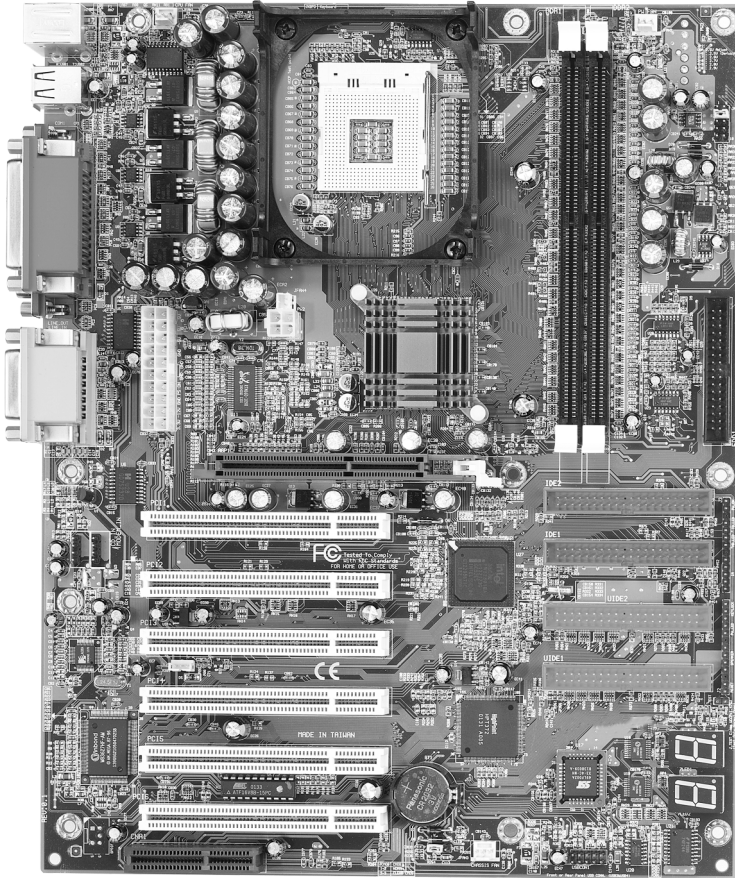

Mainboard Detailed Layout

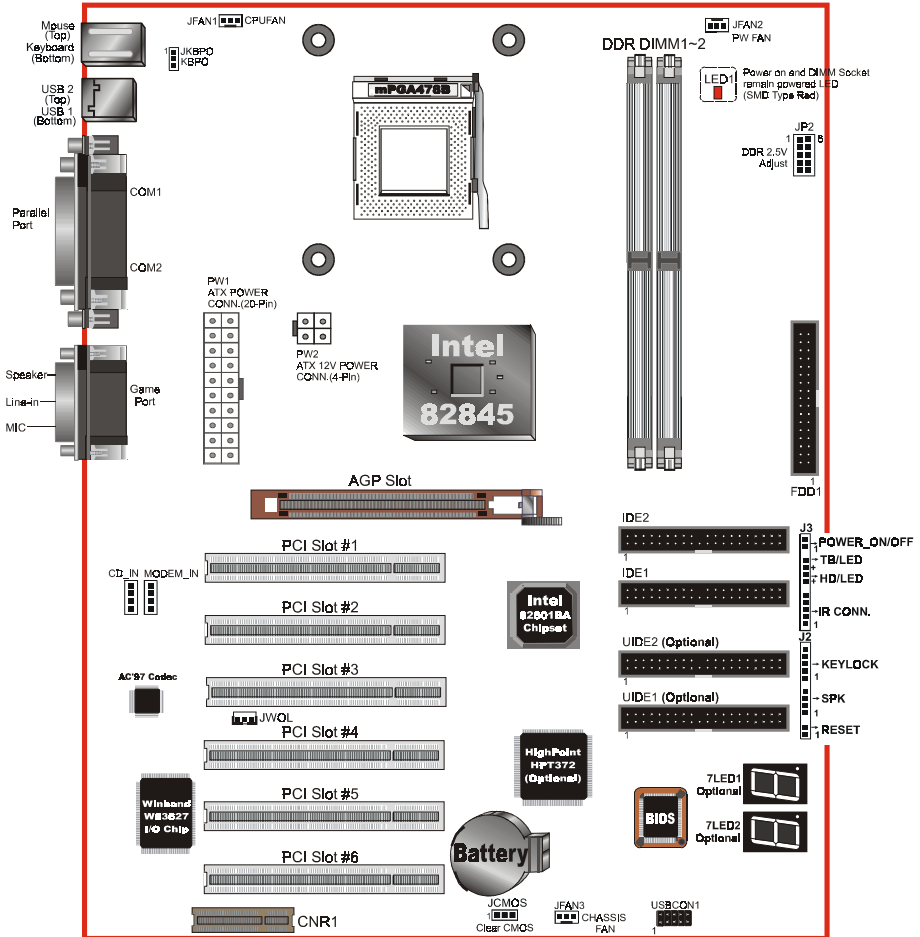

Easy Installation Procedure

The following must be completed before powering on your new system:

- 3-1. CPU Installation**
- 3-2. Jumper Settings**
- 3-3. System Memory Configuration**
- 3-4. Device Connectors**
- 3-5. External Modem Ring-in Power ON and Keyboard Power ON Functions (KBPO)**
- 3-6. STR Function**
- 3-7. 845 Platform AGP Card 3.3V Protection**

Section 3-1 CPU Installation

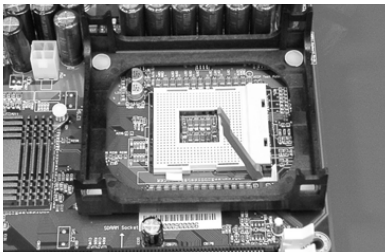

Figure 1

Step 1

Open the socket by raising the actuation lever.

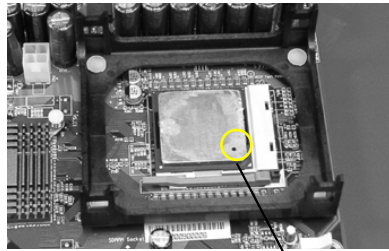

Figure 2

Pin 1

Step 2

Insert the processor.

Ensure proper pin 1 orientation by aligning the FC-PGA2 corner marking with the socket corner closest to the actuation arm tip. The pin field is keyed to prevent mis-oriented insertion. Don't force processor into socket. If it does not go in easily, check for mis-orientation and debris. Make sure the processor is fully inserted into the socket on all sides.

Installation

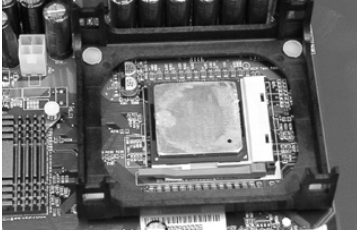

Figure 3

Step 3

Close the socket by lowering and locking the actuation lever.

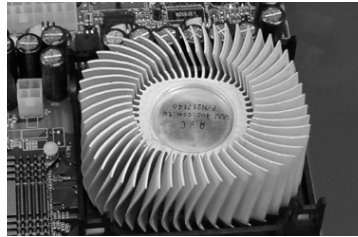

Figure 4

Step 4

Install the Fan Heatsink.

* Please do apply thermal compound between CPU and Heatsink.

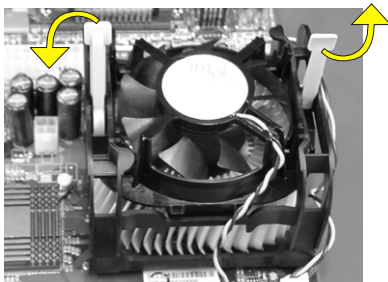

Figure 5

Step 5

Install the Shroud Assembly and follow the arrow of Figure 5 for press the two Clip Assembly.

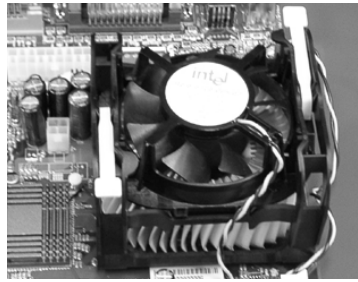

Figure 6

Step 6

Make sure the CPU fan is plugged to the CPU fan connector. The installation is completed.

NOTE:

1. Intel Pentium™ 4 processor might be crashed if installed with a regular CPU Fan since it is equipped with all new micro- architecture that brings quite small size of CPU(Die). We recommend using Intel's reference design thermal solution which is an active heatsink; an extruded aluminum heatsink based and a fan attached to the top on the fin array.
Additionally, please do apply heatsink thermal compound or paste and install CPU fan to avoid CPU overheated and damaged.
2. According to the guidance of Intel Corp, please do not install the same CPU over 50 times as it will bend the pins and damage the CPU.

Section 3-2 Jumper Settings

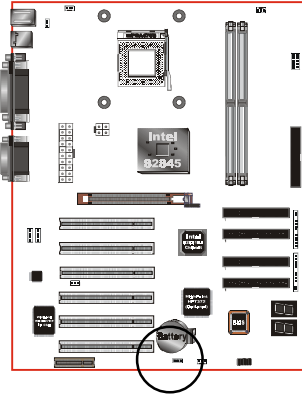

JCMOS 

- CMOS Clear
- 1-2: Normal (Default)
 - 2-3: Clear CMOS

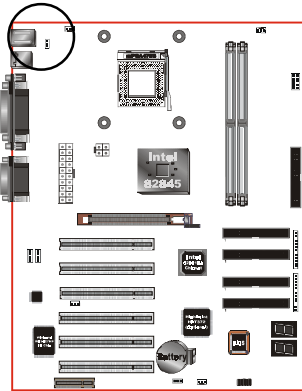

JKBPO 

- Keyboard Power On Function
- 1-2: Enabled
 - 2-3: Disabled (Default)

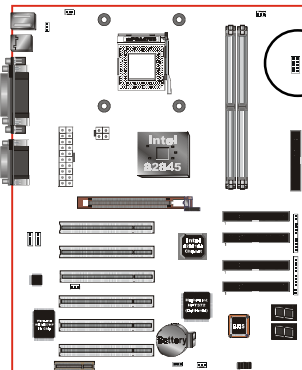

JP2 

DDR 2.5V Adjust

JP2	DDR Adjust (2.5V)
1-6	2.5V
2-7	2.6V (Default)
3-8	2.7V
4-9	2.8V
5-10	2.9V

Installation

Section 3-3 System Memory Configuration

Memory Layout

The board supports (2) PC1600/2100 184-pin DIMMs (Dual In-line Memory Module). The DIMMs is for DDR SDRAM (Double-Data-Rate Synchronous DRAM) only.

- Supports Memory Error Correcting Code (ECC).
- Supports 64Mbit, 128Mbit, 256Mbit and 512Mbit technology.
- 64-bit data width, plus & 8 bit ECC paths.
- Supports up to two unbuffered DDR DIMMs.
- Supports up to 1Gbytes of memory.

Figure 7 and Table 1 show several possible memory configurations.

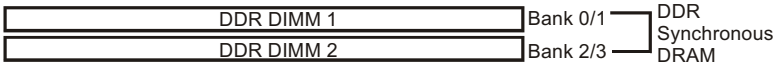

Figure 7

Total Memory	DDR DIMM 1 (Bank 0/1)	DDR DIMM 2 (Bank 2/3)
= 1GB Maximum	DDR SDRAM* 64MB, 128MB, 256MB, 512MB, 1GB* X 1	None
= 2GB Maximum	DDR SDRAM* 64MB, 128MB, 256MB, 512MB, 1GB* X 1	DDR SDRAM* 64MB, 128MB, 256MB, 512MB, 1GB* X 1

Table 1

* DDR SDRAM supports 64, 128, 256, 512MB and 1GB DIMM modules.

* 1GB module using 512Mb technology.

* Supports PC1600 modules with 2-2-2 timing.

* Supports PC2100 modules with 2-2-2 timing.

DIMM Module Installation

Figure 8 displays the notch marks and what they should look like on your DDR DIMM memory module.

DIMMs have 184-pins and one notch that will match with the onboard DDR DIMM socket. DIMM modules are installed by placing the chip firmly into the socket at a 90 degree angle and pressing straight down (figure 9) until it fits tightly into the DIMM socket (figure 10).

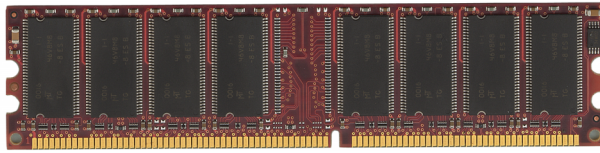

Figure 8

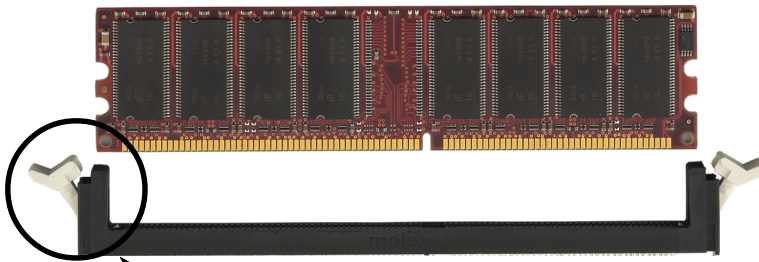

Figure 9

DIMM Module clip before installation

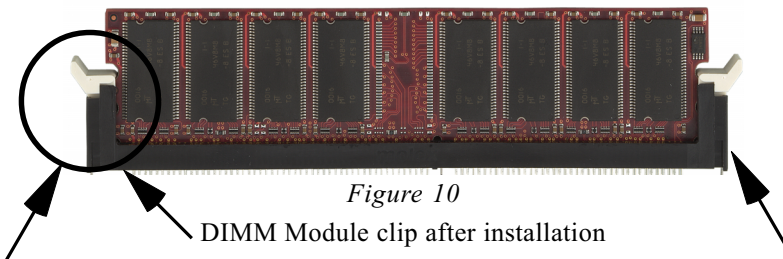

Figure 10

DIMM Module clip after installation

To remove the DIMM module simply press down both of the white clips on either side and the module will be released from the socket.

Installation

Section 3-4 Device Connectors

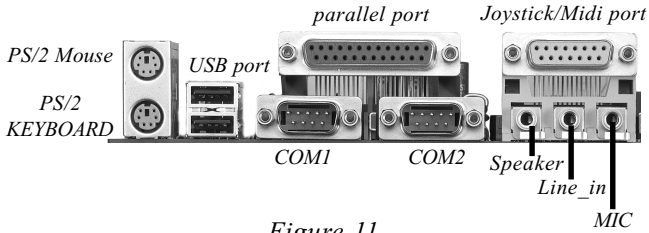
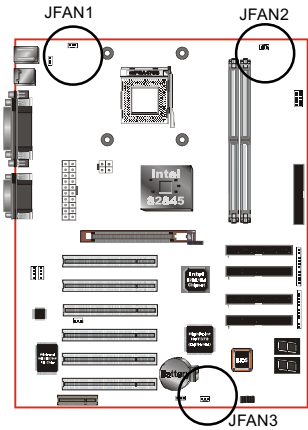

Figure 11



JFAN1 / JFAN2 / JFAN3:

- The plug-in for CPU/Power/Chassis Fan power

JFAN1:
CPU Fan

JFAN2:
PW Fan

JFAN3:
Chassis Fan

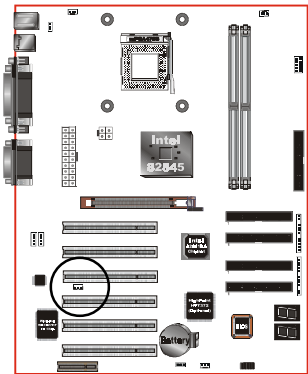
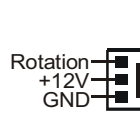

JWOL: WOL (Wake On LAN) Connector

Reserved for NIC (Network Interface Card) to wake the system.



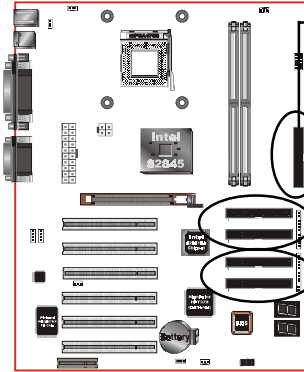

- FDD1:** Floppy Controller Connector (Black color)
- IDE1/2:** Ultra DMA-66/100 Primary/Secondary IDE Connector (Blue color)
- UIDE1/2:** Ultra DMA-66/100/133&RAID Primary/Secondary Red IDE Connector (Supported by HTP372 chipset)(**Optional**)

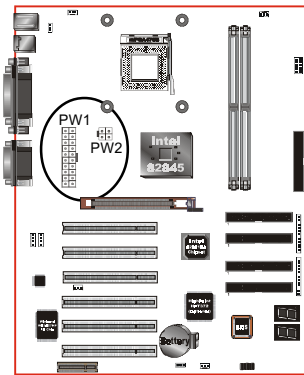

- PW1:** ATX or ATX12V Power Connector
 - 20-pin power connector
- PW2:** ATX12V Power Connector
 - 12V 4-pin power connector

Note: The board requires a minimum of 250 Watt ATX or ATX 12V power supply to operate. Your system configuration (amount of memory, add-in cards, peripherals, etc.) may exceed the minimum power requirement but to ensure that adequate power is provided, use a 300 Watt (or greater) ATX or ATX 12V power supply.

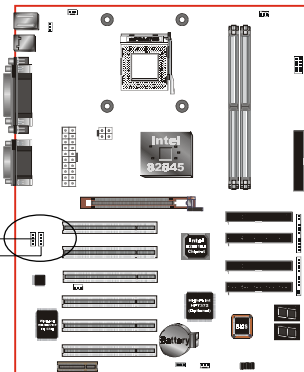

CD_IN: CD Audio_IN Connector

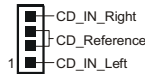

MODEM_IN: Telephony Connector for Modem audio output

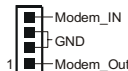

Installation

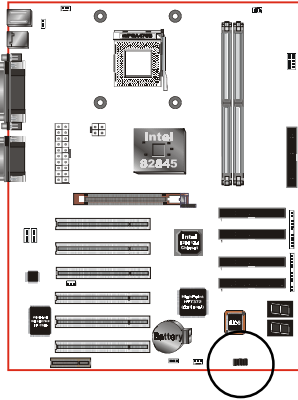

USBCON1: USB port header pins for share with two USB ports.

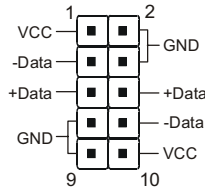

USB port header pin descriptions.

PIN#	Wire color	Signal Name	Comment
1	Red	Vcc	Cable Power
2	Black	Ground	Case Ground
3	White	-Data	Data
4	Black	Ground	Cable Ground
5	Green	+Data	Data
6	Green	+Data	Data
7	Black	Ground	Cable Ground
8	White	-Data	Data
9	Black	Ground	Case Ground
10	Red	Vcc	Cable Power

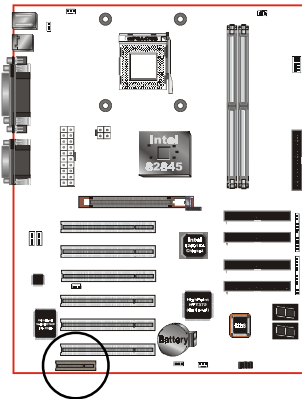

CNR Conn.: The board supports one CNR connector to provide a Modem Code (MC) or Phone-line base networking and 10/100 Ethernet base networking configuration.

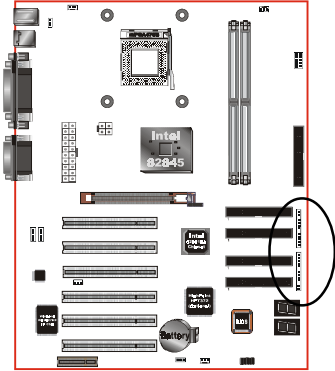

J3

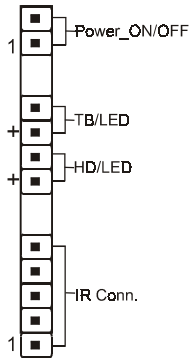

J2

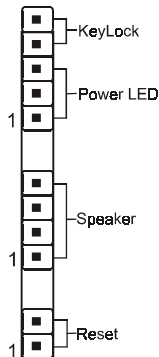

◆ **Power On/Off**

(This is connected to the power button on the case. Using the Soft-Off by Pwr-BTTN feature, you can choose either Instant Off (turns system off immediately), or 4 sec delay (you need to push the button down for 4 seconds before the system turns off). When the system is in 4 sec delay mode, suspend mode is enabled by pushing the button momentarily.)

◆ **Turbo LED indicator**

LED ON when higher speed is selected

◆ **IDE LED indicator**

LED ON when Onboard PCI IDE Hard disks is activate

◆ **IR Connector**

- | | |
|---------|---------|
| 1. VCC | 4. GND |
| 2. NC | 5. IRTX |
| 3. IRRX | |

◆ **KeyLock**

Keyboard lock switch & Power LED connector

- | | |
|-----------------|------------|
| 1. Power LED(+) | 4. KeyLock |
| 2. N/C | 5. GND |
| 3. GND | |

* The power LED lights when the system is powered on and blinks in SLEEP Mode or STR Mode.

◆ **Speaker**

Connect to the system's speaker for beeping

- | | |
|------------|--------|
| 1. Speaker | 3. GND |
| 2. N/C | 4. GND |

◆ **Reset**

Closed to restart system.

Installation

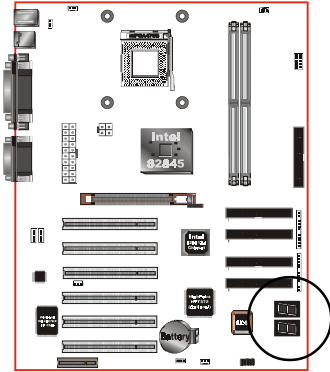

7LED2



7LED1



POST Debug 7-segment LED display on board (**Optional**).
(Please refer to Appendix E for POST codes)

Section 3-5 External Modem Ring-in Power ON and Keyboard Power ON Functions (KBPO)

On the basis of bounded functions in I/O chipset, the two serial ports are able to support the External Modem Ring-in Power ON function. Once users connect the external modem to COM1 or COM2, the mainboard allows users to turn on their system through the remote and host's dial-up control.

Exclusive Keyboard Power ON Function

To innovate a unique feature to benefit users, we devoted the easiest and most convenient way to turn on your system based on the the ATX power supply.

How to work with it

Step 1: Please check JKBPO at the position 1-2 after you finish the system installation.

JKBPO		Keyboard Power On Function
		1-2 Enabled
		2-3 Disabled (Default)

Step 2: Push the momentary switch (J3 PW-ON) to turn on your system and then push again to hold for more than 4 seconds to turn it off after counting memory as soon as you turn it on.

Step 3: You can enjoy the Keyboard Power ON function (KBPO) by *pressing any 1 key, Hot key (Ctrl-F1, F2.....F12), Password (A maximum of 5 characters can be entered.), BUTTON only...etc. to turn on your system. Please refer to the BIOS Integrated peripherals setup for detail. The BIOS Default is keyboard Hot key <Ctrl> - <F1> to turn on the system. Your system will be turned on automatically, after releasing the keys. To power off your system, you can use the Soft-OFF function under Windows 95/98/2000.*

Installation

Notes:

1. Intel ATX version 2.0 specification recommended you use the power supply with $\geq 1.0A$ in 5.0VSB. With our mainboard, *the 5.0VSB standby power only has to be $\geq 0.1A$ (100mA)* then you can enjoy this unique benefit. However, an ATX power supply which $< 0.1A$ (100mA) is still usable to your system by placed JKBPO at the position 2-3 to disable this feature.
2. We recommend you to use the power supply with 1.0A in 5.0VSB. Because it supports PCI 2.1 specification for remote power-on and wake-up function.

3-6 STR (Suspend To RAM) Function

The board supports the STR power management state by maintaining the appropriate states on the DDR SDRAM interface signals. The power source must be kept alive to the DDR SDRAM during STR (ACPI S3). Advanced Configuration Power Interface (ACPI) provides more Energy Saving Features for operating systems that supporting Instant ON and QuickStart™ function.

1. To enable the ACPI function and use the STR functionally to save your system energy, you are recommended to confirm the following requirements:
 - a. Please do install all ACPI qualified add-on cards such as AGP, LAN, Modem cards.
 - b. In BIOS, please select “ACPI function: Enable” and “ACPI Suspend Type: S3(STR)” or “USB Device Wake-Up From S3” (If you have USB Mouse/Keyboard device existence) in the Power Management Setup menu.
 - c. Then, please install the Windows® 98SE/ME or Windows® 2000.
 - d. Restart your system.
 - e. Getting in to the “Advanced” of the Power Management icon of Control Panel, and selecting the “Stand By” in the Power Buttons.
2. Getting start with STR function, please click the START button and choose Shut Down. Then, select the Stand By option in the Shut Down Windows box to get into STR mode.

Here are the differences between STR power saving mode and Green (or Suspend) mode:

- a. It is the most advanced Power Management mode
- b. It cuts all the power supplied to peripherals except to Memory - max. power saving
- c. It saves and keeps all on-screen data including any executed applications to DDR SDRAM.

Installation

- d. You must push the Power button connected with onboard J3 pin or click to USB's mouse or press USB's keyboard to wake up your system (not to click to PS/2 mouse or press PS/2 keyboard to wake up the system).

Just pushing Power button or USB's mouse/keyboard your system will quickly back to the last screen for you.

The "LED Indicator for ACPI Status" table shown below will guide you and give you a reference for ACPI status on this mainboard.

ACPI Onboard's LED Status Indicator Table					
Onboard's LED Location	Status				
	Plug in the ATX Power Core	Power ON J3(PW-ON)	Green Mode (S1)	STR (S3)	Shutdown (Soft-OFF) (S5)
LED1 (Red LED)	ON	ON	ON	ON	OFF
J2 PW_LED	OFF	ON	Blinking	Slow Blinking	OFF

3-7 845 Platform AGP Card 3.3V Protection

Due to the Intel® 845 chipset support 1.5 Volt AGP Graphics card only. If 3.3 Volt AGP card is inadvertently used in an Intel® 845 chipset based board, there is a high probability of damaging the 845(MCH) and this board. This board supports to protect the 845(MCH) and board from a 3.3V AGP Card is inadvertently used. When used a 3.3V AGP card to plug in this board, the system will not be to power on.

To power on your system normally, we recommend you to confirm the following steps:

- Step1:** Please remove the 3.3V AGP card form AGP slot.
- Step2:** Unplug in the ATX/ATX12V power core (or turn off ATX/ATX12V power supply switch)
- Step3:** Please wait for 5 ~ 7 seconds and then plug in the ATX/ATX12V power core again (or turn on ATX/ATX12V power switch) to turn on your system.

Note: There should be an interval of 5 ~ 7 seconds between unplug and plug in (or turn off and turn on) the ATX/ATX12V power.

Section 4 BIOS SETUP

Main Menu

Once you enter the AwardBIOS™ CMOS Setup Utility, the Main Menu will appear on the screen. The Main Menu allows you to select from several setup functions and two exit choices. Use the arrow keys to select among the items and press <Enter> to accept and enter the sub-menu.

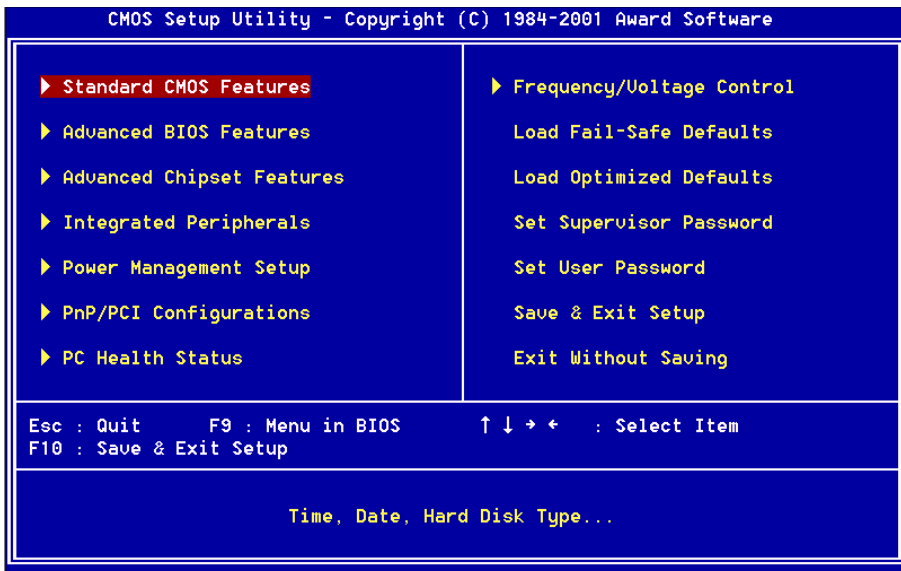

Note that a brief description of each highlighted selection appears at the bottom of the screen.

Setup Items

The main menu includes the following main setup categories. Recall that some systems may not include all entries.

Standard CMOS Features

Use this menu for basic system configuration.

BIOS

Advanced BIOS Features

Use this menu to set the Advanced Features available on your system.

Advanced Chipset Features

Use this menu to change the values in the chipset registers and optimize your system's performance.

Integrated Peripherals

Use this menu to specify your settings for integrated peripherals.

Power Management Setup

Use this menu to specify your settings for power management.

PnP / PCI Configuration

This entry appears if your system supports PnP / PCI.

PC Health Status

This item is only show the system health status (include Voltage, Fan speed, CPU temperature...)

Frequency/Voltage Control

Use this menu to specify your settings for frequency/voltage control.

Load Fail-Safe Defaults

Use this menu to load the BIOS default values for the minimal/stable performance for your system to operate.

Load Optimized Defaults

Use this menu to load the BIOS default values that are factory settings for optimal performance system operations. While Award has designed the custom BIOS to maximize performance, the factory has the right to change these defaults to meet their needs.

Supervisor / User Password

Use this menu to set User and Supervisor Passwords.

Save & Exit Setup

Save CMOS value changes to CMOS and exit setup.

Exit Without Save

Abandon all CMOS value changes and exit setup.

4-1 Standard CMOS Setup

The items in Standard CMOS Setup Menu are divided into 10 categories. Each category includes no, one or more than one setup items. Use the arrow keys to highlight the item and then use the <PgUp> or <PgDn> keys to select the value you want in each item.

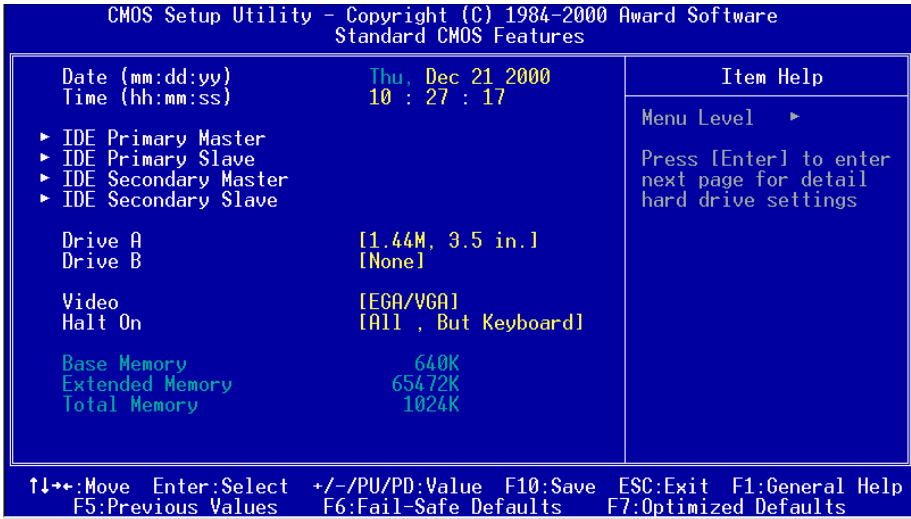

Figure 1: The Main Menu

Main Menu Selections

This table shows the selections that you can make on the Main Menu

Item	Options	Description
Date	Month DD YYYY	Set the system date. Note that the 'Day' automatically changes when you set the date
Time	HH : MM : SS	Set the system time
IDE Primary Master	Options are in its sub menu (described in Table 3)	Press <Enter> to enter the sub menu of detailed options
IDE Primary Slave	Options are in its sub menu (described in Table 3)	Press <Enter> to enter the sub menu of detailed options
IDE Secondary Master	Options are in its sub menu (described in Table 3)	Press <Enter> to enter the sub menu of detailed options
IDE Secondary Slave	Options are in its sub menu (described in Table 3)	Press <Enter> to enter the sub menu of detailed options
Drive A Drive B	None 360K, 5.25 in 1.2M, 5.25 in 720K, 3.5 in 1.44M, 3.5 in 2.88M, 3.5 in	Select the type of floppy disk drive installed in your system
Video	EGA/VGA CGA 40 CGA 80 MONO	Select the default video device
Halt On	All Errors No Errors All, but Keyboard All, but Diskette All, but Disk/Key	Select the situation in which you want the BIOS to stop the POST process and notify you
Base Memory	N/A	Displays the amount of conventional memory detected during boot up
Extended Memory	N/A	Displays the amount of extended memory detected during boot up
Total Memory	N/A	Displays the total memory available in the system

Table 2 Main Menu Selections

IDE Adapters

The IDE adapters control the hard disk drive. Use a separate sub menu to configure each hard disk drive.

Figure 2 shows the IDE primary master sub menu.

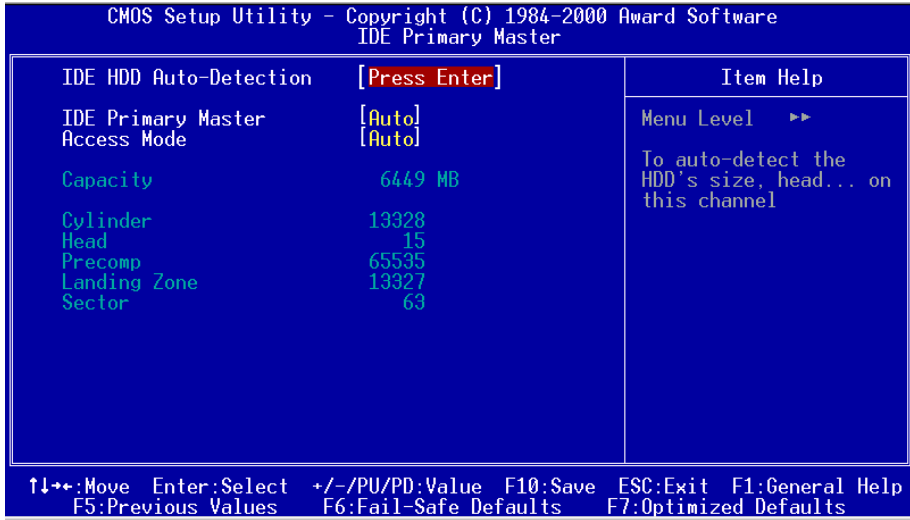

Figure 2 IDE Primary Master sub menu

BIOS

Use the legend keys to navigate through this menu and exit to the main menu. Use Table 3 to configure the hard disk.

<i>Item</i>	<i>Options</i>	<i>Description</i>
IIDE HDD Auto-detection	Press Enter	Press Enter to auto-detect the HDD on this channel. If detection is successful, it fills the remaining fields on this menu.
IDE Primary Master	None Auto Manual	Selecting 'manual' lets you set the remaining fields on this screen. Selects the type of fixed disk. "User Type" will let you select the number of cylinders, heads, etc. Note: PRECOMP=65535 means NONE !
Capacity	Auto Display your disk drive size	Disk drive capacity (Approximated). Note that this size is usually slightly greater than the size of a formatted disk given by a disk checking program.
Access Mode	Normal LBA Large Auto	Choose the access mode for this hard disk
The following options are selectable only if the 'IDE Primary Master' item is set to 'Manual'		
Cylinder	Min = 0 Max = 65535	Set the number of cylinders for this hard disk.
Head	Min = 0 Max = 255	Set the number of read/write heads
Precomp	Min = 0 Max = 65535	**** Warning: Setting a value of 65535 means no hard disk
Landing zone	Min = 0 Max = 65535	****
Sector	Min = 0 Max = 255	Number of sectors per track

Table 3 Hard disk selections

4-2 Advanced BIOS Features

This section allows you to configure your system for basic operation. You have the opportunity to select the system's default speed, boot-up sequence, keyboard operation, shadowing and security.

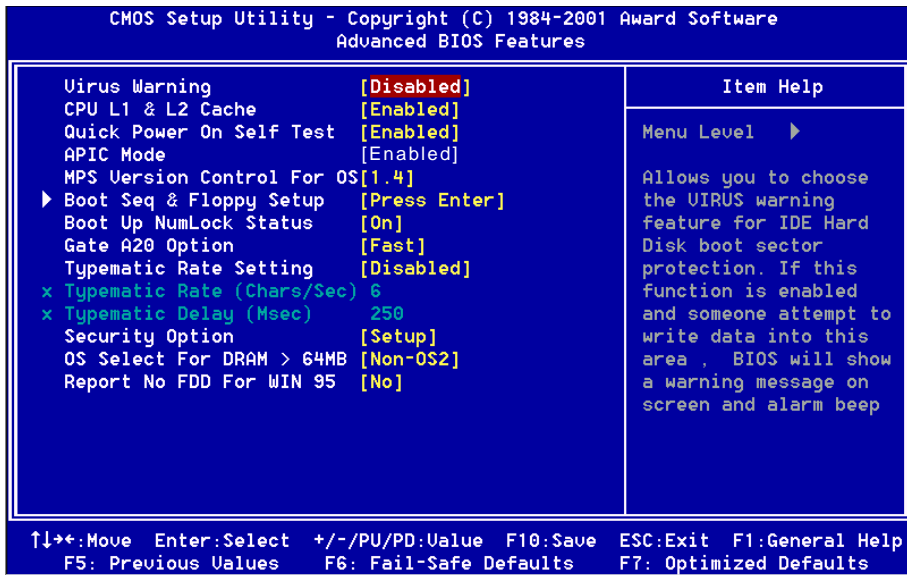

Virus Warning

Allows you to choose the VIRUS Warning feature for IDE Hard Disk boot sector protection. If this function is enabled and someone attempt to write data into this area, BIOS will show a warning message on screen and alarm beep.

Enabled: Activates automatically when the system boots up causing a warning message to appear when anything attempts to access the boot sector or hard disk partition table.

Disabled: No warning message will appear when anything attempts to access the boot sector or hard disk partition table.

CPU L1/L2 Cache

These three categories speed up memory access. However, it depends on CPU/ chipset design.

The choice: Enabled, Disabled.

BIOS

Quick Power On Self Test

This category speeds up Power On Self Test (POST) after you power up the computer. If it is set to Enable, BIOS will shorten or skip some check items during POST. The choice: Enabled, Disabled.

APIC Mode

This item allows you to enable or disable the Advanced Programmable Interrupt Controller. The choice: Enabled, Disabled.

MPS Version Control For OS

1.4: For Windows 2000.

1.1: For WinNT4.

► Boot Seq & Floppy Setup

First/Second/Third/Other Boot Device

The BIOS attempts to load the operating system from the devices in the sequence selected in these items.

The Choice: Floppy, LS120, HDD-0, SCSI, CDROM, HDD-1, HDD-2, HDD-3, ZIP100, LAN, Disabled.

Swap Floppy Drive

If the system has two floppy drives, you can swap the logical drive name assignments.

The choice: Enabled/Disabled.

Boot Up Floppy Seek

Seeks disk drives during boot up. Disabling speeds boot up.

The choice: Enabled/Disabled.

Boot Up NumLock Status

Select power on state for NumLock.

The choice: On,Off.

Gate A20 Option

Select if chipset or keyboard controller should control GateA20.

The choice: Fast, Normal.

Boot Up Floppy Seek

Seeks disk drives during boot up. Disabling speeds boot up.

The choice: Enabled, Disabled.

Typematic Rate Setting

Key strokes repeat at a rate determined by the keyboard controller. When enabled, the typematic rate and typematic delay can be selected.

The choice: Enabled, Disabled.

Typematic Rate (Chars/Sec)

Sets the number of times a second to repeat a key stroke when you hold the key down.

The choice: 6, 8, 10, 12, 15, 20, 24, 30.

Typematic Delay (Msec)

Sets the delay time after the key is held down before it begins to repeat the keystroke.

The choice: 250, 500, 750, 1000.

Security Option

Select whether the password is required every time the system boots or only when you enter setup.

System The system will not boot and access to Setup will be denied if the correct password is not entered at the prompt.

Setup The system will boot, but access to Setup will be denied if the correct password is not entered at the prompt.

Note: To disable security, select PASSWORD SETTING at Main Menu and then you will be asked to enter password. Do not type anything and just press <Enter>, it will disable security. Once the security is disabled, the system will boot and you can enter Setup freely.

OS Select For DRAM > 64MB

Select the operating system that is running with greater than 64MB of RAM on the system.

The choice: Non-OS2, OS2.

Report No FDD For WIN95

Whether report no FDD for Win95 or not.

The choice: Yes, No.

4-3 Advanced Chipset Features

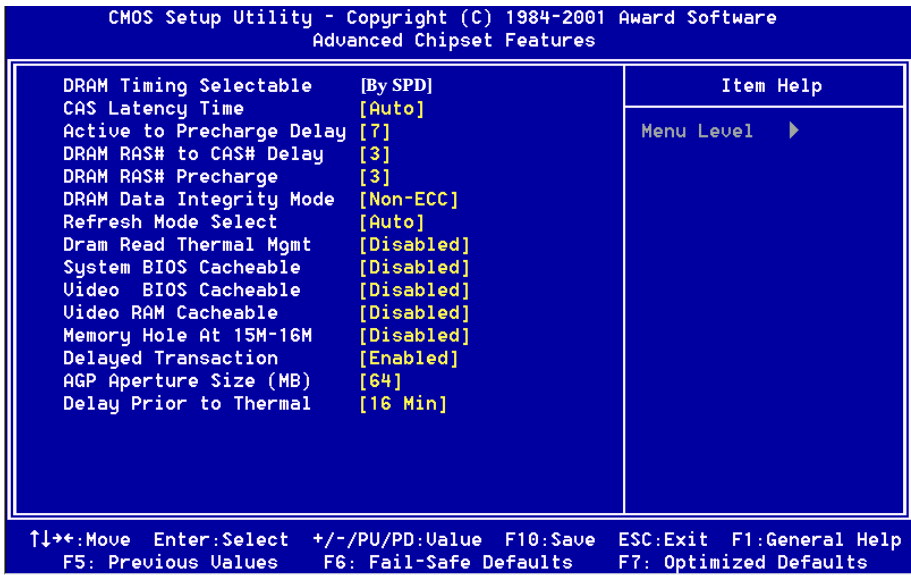

This section allows you to configure the system based on the specific features of the installed chipset. This chipset manages bus speeds and access to system memory resources, such as DRAM and the external cache. It also coordinates communications between the conventional ISA bus and the PCI bus. It must be stated that these items should never need to be altered. The default settings have been chosen because they provide the best operating conditions for your system. The only time you might consider making any changes would be if you discovered that data was being lost while using your system.

DRAM Timing Selectable

For setting DRAM Timing, By SPD is follow Intel PC DDR SDRAM Serial Presence Detect Specification.

The Choice: Normal, By SPD, Turbo.

CAS Latency Time

When synchronous DRAM is installed, the number of clock cycles of CAS latency depends on the DRAM timing.

The Choice: 2, 3, Auto.

Active to Prcharge Delay

This field lets you setup the minimum RAS pulse width.

The Choice: 7, 6, 5.

DRAM RAS# to CAS# Delay

This field lets you insert a timing delay between the CAS and RAS strobe signals, used when DRAM is written to, read from, or refreshed. *Fast* gives faster performance; and *Slow* gives more stable performance. This field applies only when synchronous DRAM is installed in the system.

The Choice: 2, 3.

DRAM RAS# Precharge

If an insufficient number of cycles is allowed for the RAS to accumulate its charge before DRAM refresh, the refresh may be incomplete and the DRAM may fail to retain data. *Fast* gives faster performance; and *Slow* gives more stable performance. This field applies only when synchronous DRAM is installed in the system.

The Choice: 2, 3.

DRAM Data Integrity Mode

Use this option to configure the type of DRAM in your system.

The choice: No-ECC, ECC.

Refresh Mode Select

Select SDRAM Refresh time, the Auto is by SPD data.

The choice: 7.8us, 15.6us, 64us, Auto.

Dram Read Thermal Mgmt

The choice: Enabled, Disabled.

System BIOS Cacheable

Selecting *Enabled* allows caching of the system BIOS ROM at F0000h-FFFFFh, resulting in better system performance. However, if any program writes to this memory area, a system error may result.

The choice: Enabled, Disabled.

Video BIOS Cacheable

Select Enabled allows caching of the video BIOS , resulting in better system performance. However, if any program writes to this memory area, a system error may result.

The Choice: Enabled, Disabled.

BIOS

Video RAM Cacheable

This option allows the CPU to cache read/writes of the video RAM.

Enabled: This option allows for faster video access.

Disabled: Reduced video performance.

Memory Hole At 15M-16M

You can reserve this area of system memory for ISA adapter ROM. When this area is reserved, it cannot be cached. The user information of peripherals that need to use this area of system memory usually discusses their memory requirements.

The Choice: Enabled, Disabled.

Delayed Transaction

The chipset has an embedded 32-bit posted write buffer to support delay transactions cycles. Select *Enabled* to support compliance with PCI specification version 2.1.

The Choice: Enabled, Disabled.

AGP Graphics Aperture Size (MB)

The amount of system memory that the AGP card is allowed to share. The default is 64.

4: 4MB of systems memory accessible by the AGP card.

8: 8MB of systems memory accessible by the AGP card.

16: 16MB of systems memory accessible by the AGP card.

32: 32MB of systems memory accessible by the AGP card.

64: 64MB of systems memory accessible by the AGP card.

128: 128MB of systems memory accessible by the AGP card.

256: 256MB of systems memory accessible by the AGP card.

Delay Prior to Thermal

Set none ACPI OS, CPU into auto thermal mode delay time, CPU 50% duty cycle when temperature over 70°C.

The Choice: 4 Min, 8 Min, 16 Min, 32 Min.

4-4 Integrated Peripherals

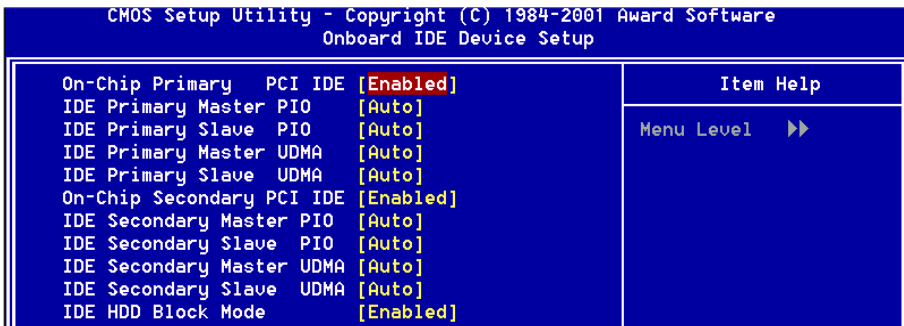
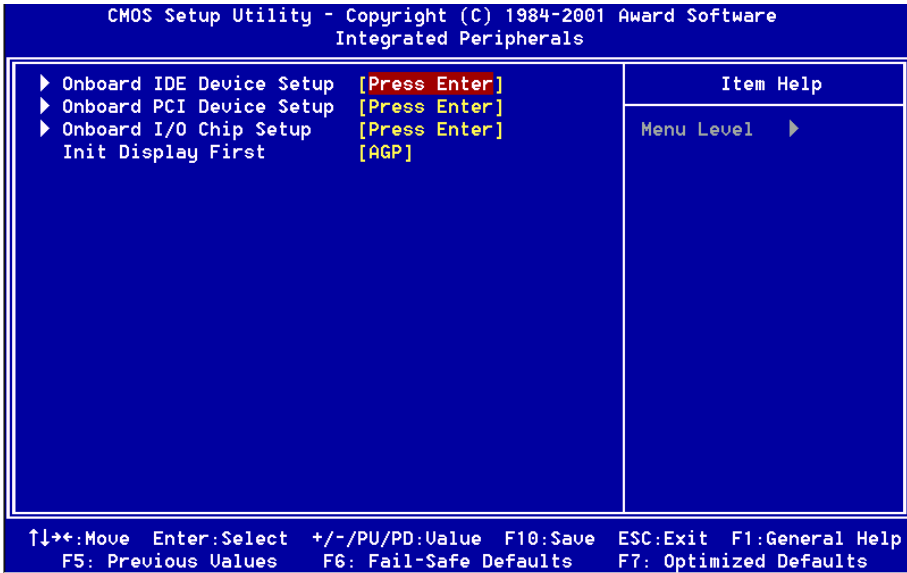

▶ On Board IDE Device Setup

OnChip Primary/Secondary PCI IDE

The integrated peripheral controller contains an IDE interface with support for two IDE channels. Select *Enabled* to activate each channel separately.

The choice: Enabled, Disabled.

BIOS

Primary/Secondary Master/Slave PIO

The four IDE PIO (Programmed Input/Output) fields let you set a PIO mode (0-4) for each of the four IDE devices that the onboard IDE interface supports. Modes 0 through 4 provide successively increased performance. In Auto mode, the system automatically determines the best mode for each device.

The choice: Auto, Mode 0, Mode 1, Mode 2, Mode 3, Mode 4.

Primary/Secondary Master/Slave UDMA

Ultra DMA/33 implementation is possible only if your IDE hard drive supports it and the operating environment includes a DMA driver (Windows 95 OSR2 or a third-party IDE bus master driver). If your hard drive and your system software both support Ultra DMA/33, select Auto to enable BIOS support.

The Choice: Auto, Disabled.

IDE HDD Block Mode

Block mode is also called block transfer, multiple commands, or multiple sector read/write. If your IDE hard drive supports block mode (most new drives do), select Enabled for automatic detection of the optimal number of block read/writes per sector the drive can support.

The choice: Enabled, Disabled

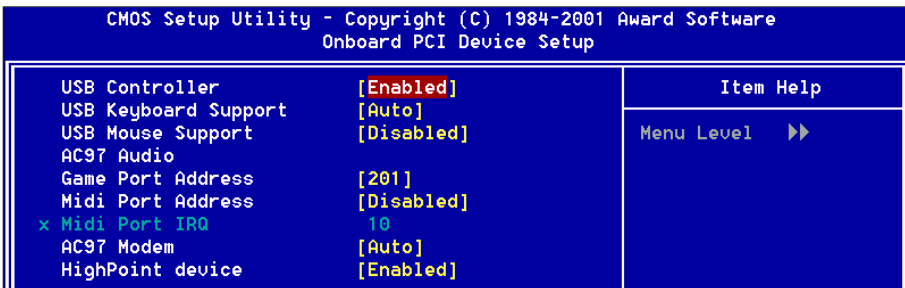

The screenshot shows the 'Onboard PCI Device Setup' screen in the CMOS Setup Utility. The title bar reads 'CMOS Setup Utility - Copyright (C) 1984-2001 Award Software'. The screen is divided into two main sections. The left section is a table listing various PCI devices and their current settings. The right section is a 'Menu Level' navigation area with an arrow pointing right.

CMOS Setup Utility - Copyright (C) 1984-2001 Award Software	
Onboard PCI Device Setup	
USB Controller	[Enabled]
USB Keyboard Support	[Auto]
USB Mouse Support	[Disabled]
AC97 Audio	
Game Port Address	[201]
Midi Port Address	[Disabled]
x Midi Port IRQ	10
AC97 Modem	[Auto]
HighPoint device	[Enabled]

Item Help
Menu Level ►►

► On Board PCI Device Setup

USB Controller

Select *Enabled* if your system contains a Universal Serial Bus (USB) controller and you have USB peripherals.

The choice: Enabled, Disabled.

USB Keyboard Support

Your system contains a Universal Serial Bus (USB) controller and you have a USB Keyboard Device, the default is Auto detect.

The choice: Enabled, Disabled, Auto.

USB Mouse Support

Select *Enabled* if your system contains a Universal Serial Bus (USB) controller and you have a USB Mouse Device.

The choice: Enabled, Disabled.

AC97 Audio

This item allows you to decide to Auto/disable the chipset family to support AC97 Audio.

The function setting AC97 Audio Codec states. The system default is Auto.

Game Port Address

Select an address for the Game port.

The choice: 201, 209, Disabled.

Midi Port Address

Select an address for the Midi port.

The choice: 290, 300, 330, Disabled.

Midi Port IRQ

Select an interrupt for the Midi port.

The choice: 5, 10.

AC97 Modem

This item allows you to decide to Auto/disable the chipset family to support AC97 Modem.

Select Auto of AC97 Modem item, you must be primary Modem Riser Card (MR) in hardware.

The choice: Auto, Disabled.

HighPoint Device (Optional)

This item can control on board PCI device HighPoint 372 series to enable or disable.

The choice: Enabled, Disabled.

CMOS Setup Utility - Copyright (C) 1984-2001 Award Software		
Onboard I/O Chip Setup		
POWER ON Function	[Hot KEY]	Item Help
KB Power ON Password	[Enter]	
Hot Key Power ON	[Ctrl-F1]	Menu Level >>
Onboard FDC Controller	[Enabled]	
Onboard Serial Port 1	[3F8/IRQ4]	
Onboard Serial Port 2	[2F8/IRQ3]	
UART Mode Select	[Normal]	
RxD , TxD Active	[Hi.Lo]	
IR Transmission Delay	[Enabled]	
UR2 Duplex Mode	[Half]	
Use IR Pins	[IR-Rx2Tx2]	
Onboard Parallel Port	[378/IRQ7]	
Parallel Port Mode	[SPP]	
EPP Mode Select	[EPP1.7]	
ECP Mode Use DMA	[3]	
PWRON After PWR-Fail	[Off]	

► On Board I/O Chip Setup

Power On Function

There are “**Button Only**”, “**Hot Key**”, “**Mouse Left**”, “**Mouse Right**” and “**Any key**” can be chosen by this field that allows users to select one of these various functions as Power On Method for their requirement. The default value in this selection is “Hot Key”. (Ctrl-F1)

Hot Key: User can press “Control Key” (Ctrl) and “Function Key” (from F1 to F12) individually to power on the system. The interval between “Ctrl” key and function Key (F1-F12) must be short.

Anykey: Press anykey to power on the system.

Mouse Left: Press Mouse Left to power on the system.

Mouse Right: Press Mouse Right to power on the system.

Button Only: This power on function controlled by J3 (pw-on.) Use Power On Button to power on the system.

Password: User can Power On the System by password, the password can be entered from 1 to 5 characters. The maximum of password is 5 characters. If user forget / lost the password, please turn off the system and open case to clear CMOS by JCMOS to re-setting the power on function. When set the password to turn on the system, than can't power on by J3(PW-ON).

KB Power On Password

When the option of “Power On Function” is password selected, user uses the item to key in password.

Hot Key Power On

Use this option with the above “Power On Function” to set a combination of keys that can be used to power the system on. The default is Ctrl-F1.

Options: Ctrl-F1, Ctrl-F2, Ctrl-F3, Ctrl-F4, Ctrl-F5, Ctrl-F6, Ctrl-F7, Ctrl-F8, Ctrl-F9, Ctrl-F10, Ctrl-F11, and Ctrl-F12.

Onboard FDC Controller

Select Enabled if your system has a floppy disk controller (FDC) installed on the system board and you wish to use it. If you install and-in FDC or the system has no floppy drive, select Disabled in this field.

The choice: Enabled, Disabled.

Onboard Serial Port 1/Port 2

Select an address and corresponding interrupt for the first and second serial ports.

The choice: 3F8/IRQ4, 2E8/IRQ3, 3E8/IRQ4, 2F8/IRQ3, Disabled.

UART Mode Select

This field allows the users to configure what IR mode the 2nd serial port should use. The default is Normal.

Optional: Normal, IrDA and ASKIR.

RxD, TxD Active

This field configures the receive and transmit signals generated from the IR port. The default is Hi Lo (when UART Mode Select is not set to Normal).

Options: Hi Hi, Hi Lo, Lo Hi, and Lo Lo.

IR Transmission delay

The default is Enabled (when UART Mode Select is not set to Normal).

Options: Enabled and Disabled.

UR2 Duplex Mode

This item allows you to select IR half/full duplex function.

The choice: Half, Full

Use IR Pins

This item allows you to select IR transmission routes, one is Rx2, Tx2 (COM Port) and the other is IR-Rx2Tx2.

The choice: IR-Rx2Tx2, Rx2, Tx2.

Onboard Parallel port

This field allows the user to configure the LPT port. The default is 378H / IRQ7.

378H: Enable Onboard LPT port and address is 378H and IRQ7.

278H: Enable Onboard LPT port and address is 278H and IRQ5.

3BCH: Enable Onboard LPT port and address is 3BCH and IRQ7.

Disabled: Disable Onboard LPT port.

Parallel Port Mode

This field allows the user to select the parallel port mode.

Normal: Standard mode. IBM PC/AT Compatible bidirectional parallel port.

EPP: Enhanced Parallel Port mode.

ECP: Extended Capabilities Port mode.

EPP+ECP: ECP Mode & EPP Mode.

EPP Mode Select

This item allows you to determine the IR transfer mode of onboard I/O chip.

options: EPP1.9, EPP1.7.

ECP Mode USE DMA

This field allows the user to select DMA1 or DMA3 for the ECP mode.

The default is DMA3.

DMA1: This field selects the routing of DMA1 for the ECP mode.

DMA3: This field selects the routing of DMA3 for the ECP mode.

PWRON After PWR-Fail

The system will stay off or power on after a power interrupte.

The default is OFF.

Former-Status: Stay off or power on depend on system safe shut-down or power fail.

ON: System always power on after a power interrupte.

OFF: System always stay off after a power interrupte.

Init Display First

This item allows you to decide to active whether PCI Slot or on-chip VGA first
The choice: PCI Slot, Onboard .

4-5 Power Management Setup

The Power Management Setup allows you to configure you system to most effectively save energy while operating in a manner consistent with your own style of computer use.

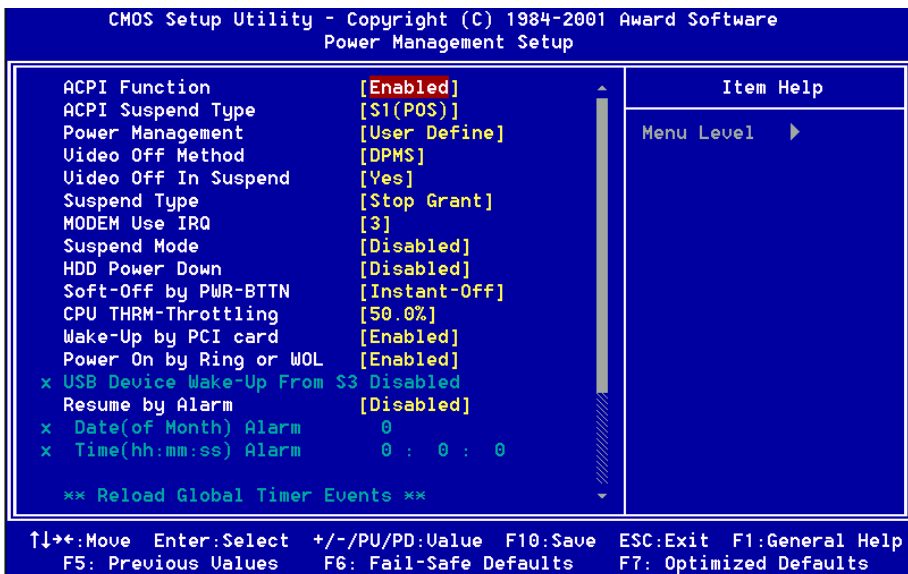

ACPI Function

This item allows you to enable/disable the Advanced Configuration and Power Management (ACPI).

The choice: Enabled, Disabled.

ACPI Suspend Type

This item allows you to select S1(POS) or S3(STR) function.

The choice: S1(POS), S3(STR).

BIOS

Power Management

This category allows you to select the type (or degree) of power saving and is directly related to the following modes:

1. HDD Power Down
2. Suspend Mode

There are four selections for Power Management, three of which have fixed mode settings.

Disable (default)	No power management. Disables all four modes
Min. Power Saving	Minimum power management. Doze Mode = 1 hr. Standby Mode = 1 hr., Suspend Mode = 1 hr., and HDD Power Down = 15 min.
Max. Power Saving	Maximum power management -- ONLY AVAILABLE FOR SL CPU's. Doze Mode = 1 min., Standby Mode = 1 min., Suspend Mode = 1 min., and HDD Power Down = 1 min.
User Defined	Allows you to set each mode individually. When not disabled, each of the ranges are from 1 min. to 1 hr. except for HDD Power Down which ranges from 1 min. to 15 min. and disable.

Video Off Method

This determines the manner in which the monitor is blanked.

V/H SYNC+Blank	This selection will cause the system to turn off the vertical and horizontal synchronization ports and write blanks to the video buffer.
Blank Screen	This option only writes blanks to the video buffer.
DPMS	Initial display power management signaling.

Video Off In Suspend

This determines the manner in which the monitor is blanked.

The choice: Yes, No.

Suspend Type

Select the Suspend Type.

The choice: PWRON Suspend, Stop Grant.

MODEM Use IRQ

This determines the IRQ in which the MODEM can use.

The choice: 3, 4, 5, 7, 9, 10, 11, NA.

Suspend Mode

When enabled and after the set time of system inactivity, all devices except the CPU will be shut off.

The choice: Enabled, Disabled.

HDD Power Down

When enabled and after the set time of system inactivity, the hard disk drive will be powered down while all other devices remain active.

The choice: Enabled, Disabled.

Soft-Off by PWR-BTTN

Pressing the power button for more than 4 seconds forces the system to enter the Soft-Off state when the system has “hung.” The default is Instant-off.

The choice: Delay 4 Sec, Instant-Off.

CPU THRM-Throttling

Select the CPU THRM-Throttling rate.

The choice: 25.0%, 37.5%, 50.0%, 62.5%, 75.0%, 87.5%.

Wake-Up by PCI Card

An input signal from PME on the PCI card awakens the system from a soft off state.

The choice: Enabled, Disabled.

Power On by Ring or WOL

This option is used to set the remote ring in and Wake on LAN (WOL) features.

The choice: Enabled, Disabled.

USB Device Wake-Up From S3

This item allows you to select wake-up the system by USB Mouse/Keyboard when you save the computer power at S3 mode.

The choice: Enabled, Disabled.

Resume by Alarm

The option allows you to have the system turn on at a present time each day or on a certain day.

The choice: Disabled, Enabled.

BIOS

**** *PM Events* ****

PM events are I/O events whose occurrence can prevent the system from entering a power saving mode or can awaken the system from such a mode. In effect, the system remains alert for anything which occurs to a device which is configured as *Enabled* , even when the system is in a power down mode.

Primary IDE 0

Primary IDE 1

Secondary IDE 0

Secondary IDE 1

FDD, COM, LPT Port

PCI PIRQ[A-D] #

4-6 PnP/PCI Configuration Setup

This section describes configuring the PCI bus system. PCI, or **Personal Computer Interconnect**, is a system which allows I/O devices to operate at speeds nearing the speed the CPU itself uses when communicating with its own special components. This section covers some very technical items and it is strongly recommended that only experienced users should make any changes to the default settings.

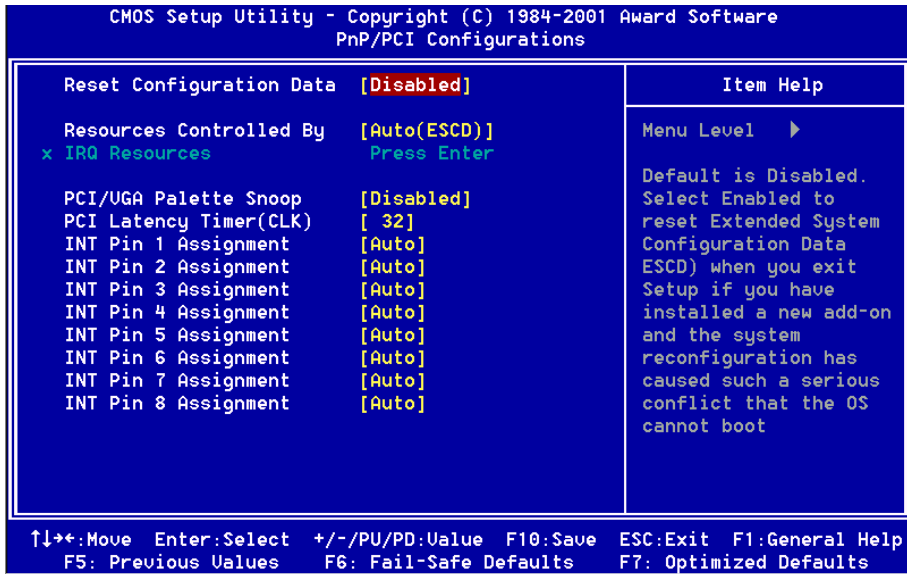

Reset Configuration Data

Normally, you leave this field Disabled. Select Enabled to reset Extended System Configuration Data (ESCD) when you exit Setup if you have installed a new add-on and the system reconfiguration has caused such a serious conflict that the operating system can not boot.

The choice: Enabled, Disabled .

Resource controlled by

The Award Plug and Play BIOS has the capacity to automatically configure all of the boot and Plug and Play compatible devices. However, this capability means absolutely nothing unless you are using a Plug and Play operating system such as Windows95. If you set this field to “manual” choose specific resources by going

BIOS

into each of the sub menu that follows this field.

The choice: Auto(ESCD), Manual.

PCI/VGA Palette Snoop

Leave this field at *Disabled*.

The Choice: Enabled, Disabled.

PCI Latency Timer (CLK)

The latency timer defines the minimum amount of time, in PCI clock cycles, that the bus master can retain the ownership of the bus.

The Choice: 0 ~ 255.

INT Pin 1 to Pin 8 Assignment

These settings allows the user to specify what IRQ will be assigned to PCI devices in the chosen slot. The default is Auto.

The Choice: Auto, 3, 5, 7, 9, 10, 11, 12, 14 & 15.

Interrupt request are shared as shown the table below:

	INT A	INT B	INT C	INT D	INT E	INT F	INT G	INT H
AGP Slot	√							
AC97/MC97		√						
Slot 1			√					
Slot 2				√				
Slot 3					√			
Slot 4						√		
Slot 5							√	
Slot 6								√
CNR LAN	√							
Onboard USB 1				√				
Onboard USB 2								√
SM BUS		√						

IMPORTANT! *If using PCI cards on shared slots, make sure that the drivers support “Shared IRQ” or that the cards don’t need IRQ assignments. Conflicts will arise between the two PCI groups that will make the system unstable or cards inoperable.*

4-7 PC Health Status

CMOS Setup Utility - Copyright (C) 1984-2001 Award Software		PC Health Status	
Show PC Health in Post	[Enabled]	Item	Help
CPU Warning Temperature	[Disabled]	Menu Level	▶
Current CPU Temp.	[40°C/91°F]		
Current System Temp.	[30°C/138°F]		
Current Chassis Fan Speed	[0 RPM]		
Current CPU Fan Speed	[0 RPM]		
Current Power Fan Speed	[0 RPM]		
Vagp (V)	[1.50V]		
Ucore(U)	[1.75V]		
Udimm(U)	[3.30V]		
+ 5 U	[4.97V]		
+12 U	[12.12V]		
-12 U	[-12.28V]		
- 5 U	[-5.09V]		
UBAT(U)	[3.48V]		
5USB(U)	[4.89V]		
Shutdown Temperature	[Disabled]		

↑↓→←:Move Enter:Select +/-/PU/PD:Ualue F10:Save ESC:Exit F1:General Help
 F5: Previous Values F6: Fail-Safe Defaults F7: Optimized Defaults

Show PC Health in Post

When enable this function, you can see PC Health in Post screen.

The choice: Enabled, Disabled.

CPU Warning Temperature

This is the temperature that the computer will respond to an overheating CPU. The default is Disabled.

Enabled: Temperature is monitored on the CPU.

Disabled: This feature is turned off.

Current CPU / System Temperature

This is the current temperature of the CPU/System.

Current CPU Fan / Chassis Fan / Power Fan Speed

The current CPU/Chassis/Power fan speed in RPMs.

Vagp (V)

The voltage level of Power supplied to AGP card.

BIOS

Vcore (V)

The voltage level of the Vcore.

Vdimm (V)

The voltage level of the DRAM.

+5V, +12V, -5V, -12V, VBAT(V), 5VSB(V): The voltage level of the switch power supply.

Shutdown Temperature

This is the temperature that the computer will turn off the power to combat the effects of an overheating system. (requires ACPI to be enabled in Power Management BIOS and ACPI compliant operating system.) The default is Disabled.

Options available are 60°C/140°F to 75°C/167°F in increments of 5°C.

4-8 Frequency/Voltage Control

CMOS Setup Utility - Copyright (C) 1984-2001 Award Software Frequency/Voltage Control		Item Help
CPU Clock Ratio	[X8]	
Auto Detect PCI Clk	[Enabled]	
Spread Spectrum Modulated	[Disabled]	Menu Level ▶
CPU FSB/SPEED	[100MHz/800 MHz]	
Memory Frequency	[Auto]	
Next boot AGP/PCI is	66/33MHz-DRAM is 133MHz	
AGP/PCI Clock	[AUTO]	
Default CPU Ucore Voltage	[1.75V]	
CPU Ucore Voltage	[+0.000 U]	
New CPU Ucore Voltage	[1.75V]	
Default AGP Voltage	[1.50V]	
AGP Voltage	[+0.00 U]	
New AGP Voltage	[1.50V]	
↑↓+:-Move Enter:Select +/-/PU/PD:Ualue F10:Save ESC:Exit F1:General Help F5: Previous Values F6: Fail-Safe Defaults F7: Optimized Defaults		

CPU Clock Ratio

This item allows you to select the CPU ratio. If the CPU ratio is fixed. This item was no function.

The choice: [x8]...[x24].

Auto Detect PCI Clk

This item allows you to disable the each PCI slot clock.

Spread Spectrum Modulated

This item allows you to enable/disable the spread spectrum modulate.

CPU FSB/Speed

The mainboard is designed to set the CPU FSB/Speed via BIOS. This item allows you to adjust CPU clock 1MHz by step. The default speed depends on what CPU was installed.

Note: Overclocking failure will cause system No display problem. At this moment, please press “Insert” key to back to the initial or default setting to boot up your system.

BIOS

Memory Frequency

This item allows you to select the memory frequency. The default is Auto, this option follows spd data to set memory frequency clock.

The option: Auto, FSB, FSB*4/3.

AGP/PCI Clock

This item allows you to select the AGP/PCI Clock. The default is Auto, if FSB > 117MHz then AGP/PCI fixed to 66MHz/33MHz.

The option: Auto, AGP-FSB*2/3 PCI-FSB/3, AGP-66MHz PCI-33MHz.

CPU Vcore Voltage

This item allows you to increase the CPU Vcore Voltage.

The option: $\pm 0.025V$ increment.

AGP Voltage

This item allows you to increase the Vagp Voltage. (Applicable when you plug in AGP card).

The option: +0.1V increment.

4-9 Defaults Menu

Selecting “Defaults” from the main menu shows you two options which are described below

Load Fail-Safe Defaults

When you press <Enter> on this item you get a confirmation dialog box with a message similar to:

Load Fail-Safe Defaults (Y/N) ? N

Pressing ‘Y’ loads the BIOS default values for the most stable, minimal-performance system operations.

Load Optimized Defaults

When you press <Enter> on this item you get a confirmation dialog box with a message similar to:

Load Optimized Defaults (Y/N) ? N

Pressing ‘Y’ loads the default values that are factory settings for optimal performance system operations.

4-10 Supervisor/User Password Setting

You can set either supervisor or user password, or both of them. The differences between are:

supervisor password : can enter and change the options of the setup menus.

user password : just can only enter but do not have the right to change the options of the setup menus. When you select this function, the following message will appear at the center of the screen to assist you in creating a password.

ENTER PASSWORD:

Type the password, up to eight characters in length, and press <Enter>. The password typed now will clear any previously entered password from CMOS memory. You will be asked to confirm the password. Type the password again and press <Enter>. You may also press <Esc> to abort the selection and not enter a password. To disable a password, just press <Enter> when you are prompted to enter the password. A message will confirm the password will be disabled. Once the password is disabled, the system will boot and you can enter Setup freely.

PASSWORD DISABLED.

When a password has been enabled, you will be prompted to enter it every time you try to enter Setup. This prevents an unauthorized person from changing any part of your system configuration.

Additionally, when a password is enabled, you can also require the BIOS to request a password every time your system is rebooted. This would prevent unauthorized use of your computer.

You determine when the password is required within the BIOS Features Setup Menu and its Security option. If the Security option is set to “System”, the password will be required both at boot and at entry to Setup. If set to “Setup”, prompting only occurs when trying to enter Setup.

4-11 Exit Selecting

Save & Exit Setup

Pressing <Enter> on this item asks for confirmation:

Save to CMOS and EXIT (Y/N)? Y

Pressing “Y” stores the selections made in the menus in CMOS – a special section of memory that stays on after you turn your system off. The next time you boot your computer, the BIOS configures your system according to the Setup selections stored in CMOS. After saving the values the system is restarted again.

Exit Without Saving

Pressing <Enter> on this item asks for confirmation:

Quit without saving (Y/N)? Y

This allows you to exit Setup without storing in CMOS any change. The previous selections remain in effect. This exits the Setup utility and restarts your computer.

Section 5 845 and Sound Driver Installation

Easy Driver Installation

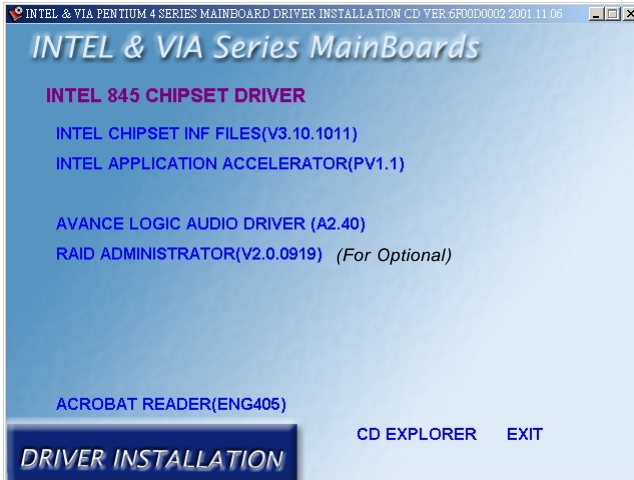

Insert the bundled autorun driver CD-disk.

- Step 1 :** Click the **INTEL CHIPSET INF FILES** to install all components recommended.
- Step 2 :** Click the **INTEL ULTRA STORAGE DRIVER** or **Intel APPLICATION ACCELERATOR** to install ultra storage.
- Step 3 :** Click the **AVANCE LOGIC AUDIO DRIVER** to install audio.
- Step 4 :** Click the **RAID ADMINISTRATOR** to install Raid Administrator. (For Optional)

A-1 Avance® Media Player User's Guide

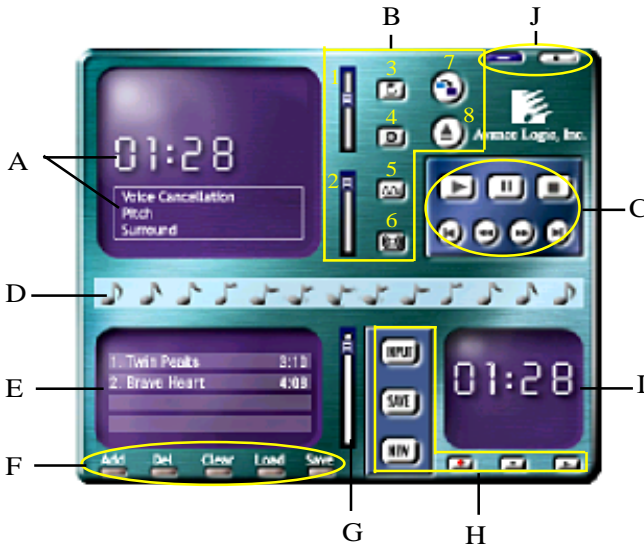
Avance® Media Player Platform**Functional Descriptions****A. Playback Windows Display**

Playback windows displays the following mode information:

1. Playback Time Display
2. Voice Cancellation Mode Display
3. Pitch Mode Display
4. Surround Sound Mode Display

B. Playback Function Controls

There are 8 selectable functions for the playback:

1. Volume control High/Low Adjustment Bar.
2. Pitch control 4-step High/Low Adjustment Bar.

Appendix

3. Repeat mode Choice of Repeat, All Repeat, Random or No Repeat Mode.
4. Mute Mute On/Off Mode select.
5. Voice cancellation Voice Cancellation On/Off Mode select for Karaoke.
6. Surround mode A total of 26 Surround Sound mode select as shown in the table below.

Surround mode	Surround mode
Generic	Stone corridor
Padded	Alley
Room	Forrest
Bathroom	City
Living room	Mountain
Stone	Quarry
Auditorium	Plain
Concert	Parking lot
Cave	Sewer pipe
Arena	Under water
Hangar	Drug
Carpet	Dizzy
Hallway	Psychological

7. Skin change Media Player Skin Type select.
8. Open Open file formats including MP3, CDA, MDI, WAV & WMA support.

C. Playback Controls

The playback controls include “Play”, “Pause”, “Stop”, “Previous”, “Backward”, “Forward”, & “Next”.

D. Seeking bar

Display Animated Playback Status

E. Title/Play List Windows

Display Currently Selected Title(s)

F. Title/Play List Edit Controls

These title/play list controls include “Add”, “Del”, “Clear”, “Load”, & “Store”.

1. Add Add to the Title/Play List.
2. Del Remove form the Title/Play List.
3. Clear Clear the Title/Play Lost.
4. Load Load Title/Play List.
5. Store Save Title/Play List.

G. Title/Play List Scroll bar

Scroll Up/Down the Title/Play List.

H. Recording Function Controls

The recording function controls include “Input”, “Save:”, “New”, “Rec”, “Stop”, & “Play”.

1. Input Input soruce select.
2. Save Save to file.
3. New Open new file & select format includes Sampling Rate, Sampling bit, Mono or Stereo.
4. Rec Start Rec.
5. Stop Stop Rec.
6. Play Playback Rec file.

I. REC/Playback Time Display

Displays REC/Playback Time.

J. Platform Display Panel Controls

The platform display panel control include “Minimize” & “Close”.

1. Minimize Minimize Platform Display Panel.
2. Close Close/Exit Platform Display Panel.

B-1 GHOST 5.1/6.03 Quick User's Guide

Installation is very easy. You only need to copy the **Ghost5** folder or **Ghost.exe** to your hard disk.

The current market version is for single **Client**, so the LPT and NetBios portions will not be explained further.

Description of Menus

Ghost clones and backs up **Disk** and **Partition**.

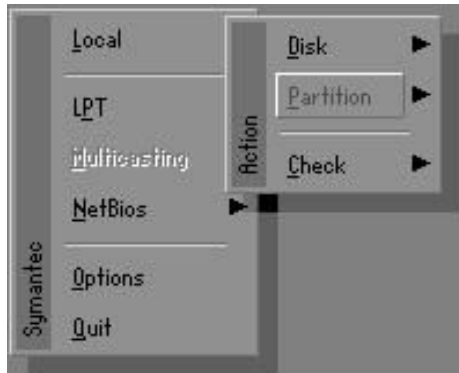

In which **Disk** indicates hard disk options
Partition indicates partition options
Check indicates check options

Disk

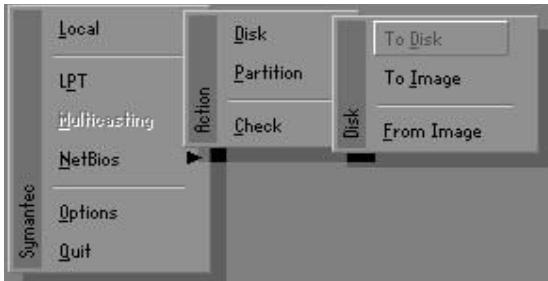

Appendix

There are 3 hard disk functions:

1. Disk To Disk (disk cloning)
2. Disk To Image (disk backup)
3. Disk From Image (restore backup)

Important!

1. To use this function, the system must have at least 2 disks. Press the **Tab** key to move the cursor.
2. When restoring to a destination disk, all data in that disk will be completely destroyed.

Disk To Disk (Disk Cloning)

1. Select the location of the **Source** drive.
2. Select the location of the **Destination** drive.

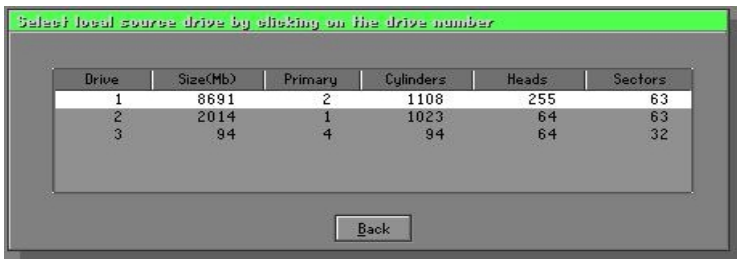

3. When cloning a disk or restoring the backup, set the required partition size as shown in the following figure.



- Click OK to display the following confirmation screen. Select **Yes** to start.

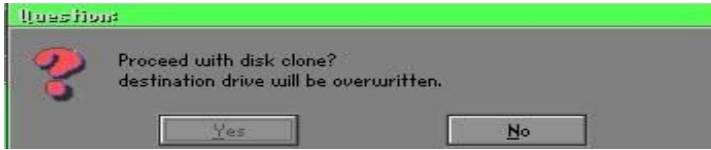

Disk To Image (Disk Backup)

- Select the location of the Source drive.

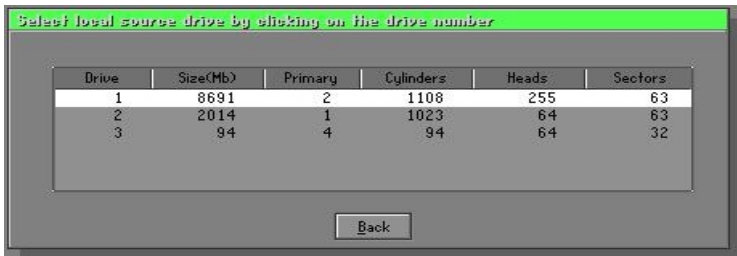

- Select the location for storing the backup file.

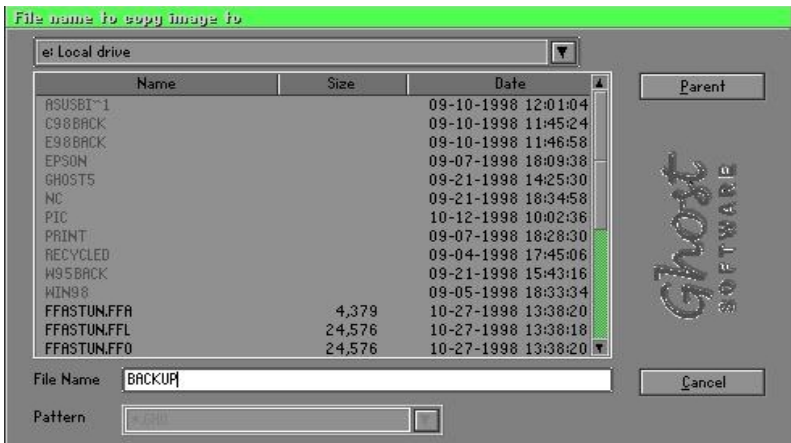

Appendix

- Click **OK** to display the following confirmation screen. Select **Yes** to start.



Disk From Image (Restore Backup)

- Select the Restore file.

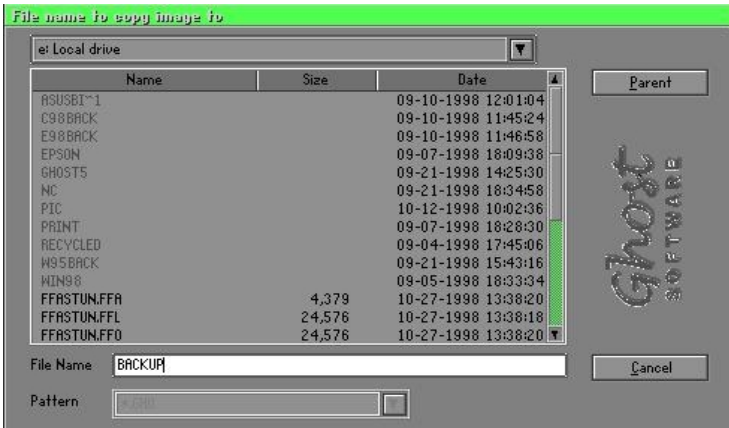

- Select the **Destination drive** of the disk to be restored.

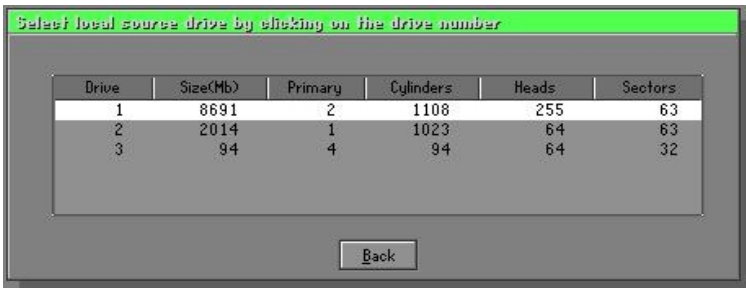

- When restoring disk backup, set the required partition size as shown in the following figure.

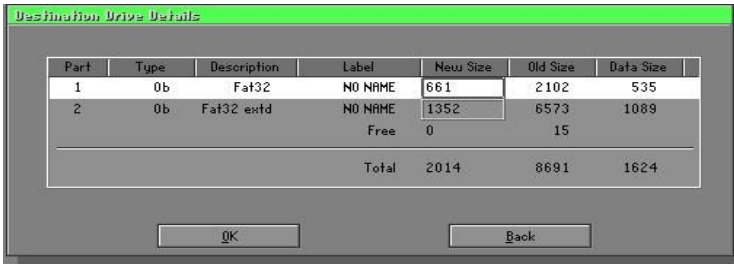

- Click **OK** to display the following confirmation screen. Select **Yes** to start.

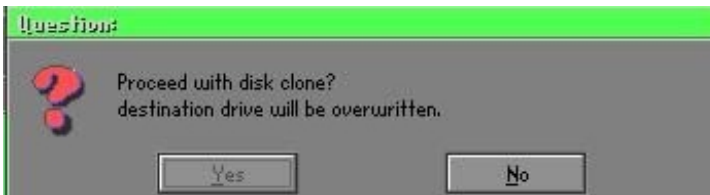

Partition

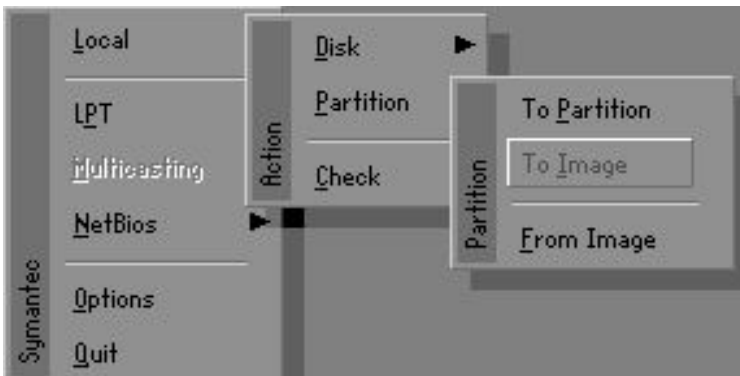

Appendix

There are 3 partition functions:

1. **Partition To Partition** (partition cloning)
2. **Partition To Image** (partition backup)
3. **Partition From Image** (restore partition)

Partition To Partition (Partition Cloning)

The basic unit for partition cloning is a partition. Refer to disk cloning for the operation method.

Partition To Image (Partition Backup)

1. Select the disk to be backed up.

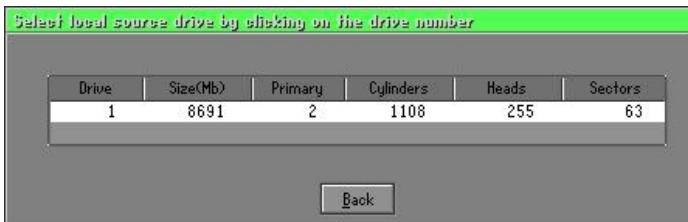

2. Select the first partition to be backed up. This is usually where the operating system and programs are stored.



3. Select the path and file name for storing the backup file.

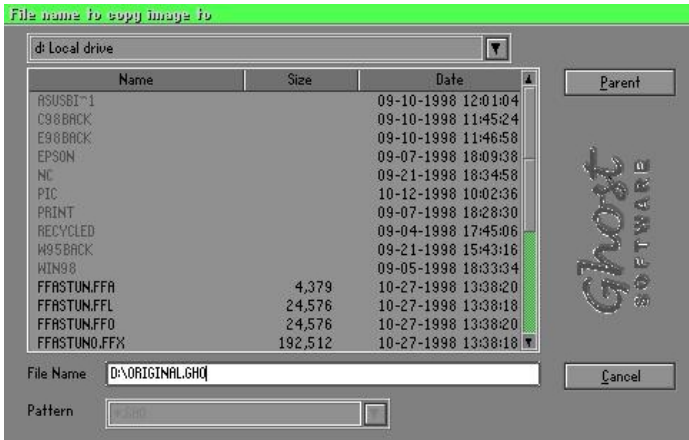

4. Is the file compressed? There are 3 options:

(1) No: do not compress data during backup

(2) Fast: Small volume compression

(3) High: high ratio compression. File can be compressed to its minimum, but this requires longer execution time.

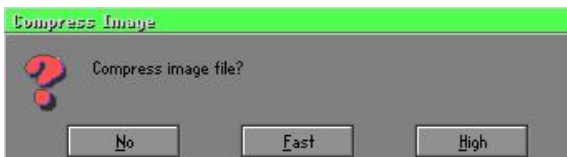

5. During confirmation, select Yes to start performing backup.

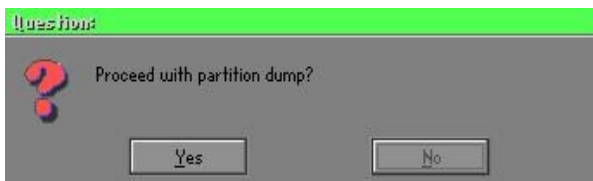

Appendix

Partition From Image (Restore Partition)

1. Select the backup file to be restored.

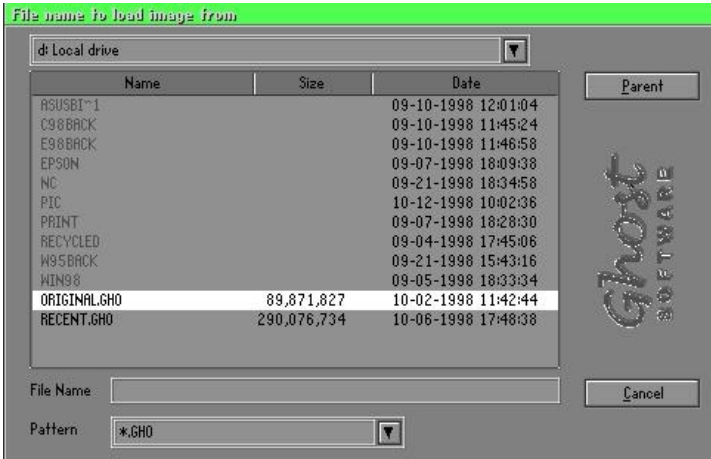

2. Select the source partition.



3. Select the disk to be restored.



4. Select the partition to be restored.



5. Select Yes to start restoring.

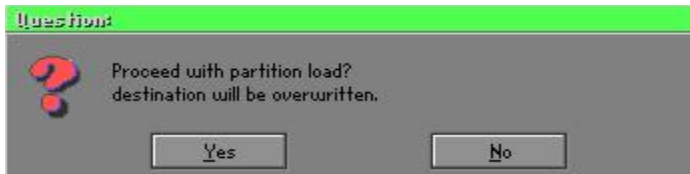

Check

This function checks the hard disk or backup file for backup or restoration error due to FAT or track error.

How to Reinstall Windows in 2 Minutes

This chapter teaches you how to set your computer properly and, if necessary, reinstall Windows in 2 minutes. Ghost can use different methods to complete this task. The following two sections explain the creation of the emergency Recover Floppy and Recover CD:

Emergency Recover Floppy

Divide a hard disk into two partitions. The first partition is for storing the operating system and application programs. The second partition is for backing up the operating system and data. The size of the partition can be set according to the backup requirements. For example, the **Windows** operating system needs 200MB of hard disk space, while the complete **Office** installation requires 360MB. The remaining space can be used to store other data.

After installing **Windows**, use **Ghost** to create a backup of the source system and store the file (Image file) in drive D. The file is named as **Original.gho**. Then, create a recover floppy disk containing:

- ◆ Bootable files (Command.com, Io.sys, and MSDOS.SYS)
- ◆ Config.sys (configuration setup file)
- ◆ Autoexec.bat (auto-execution batch file)
- ◆ Ghost.exe (Ghost execution file)

There are two ways to set the content of the recover floppy for restoration:

- (1) To load **Windows** automatically after booting, set the **Autoexec.bat** command as:

```
Ghost.exe clone, mode=pload, src=d:\original.gho:2,dst=1:1 -fx -sure -rb
```

Description: Runs the restore function automatically using the Image File. After execution, it exits Ghost and boots the system automatically.

Refer to the [Introducing Ghosts Functions].

- (2) After booting, the screen displays the Menu. Select Backup or Restore: Since the user may install other applications in the future, he/she may design **Autoexec.bat** as a Menu to back up or restore the user-defined Image file as follows:

Backup

Back up Windows and application programs as a file (Recent.gho). Command is:

```
Ghost -clone,mode=pdump,src=1:1,dst=d:\Recent.gho -fx -sure -rb
```

Restore

Restore types include [**General Windows**] and [**Windows and Application Programs**]. If you select [**General Windows**], the system is restored to the general **Windows** operation condition. The command is:

```
Ghost.exe -clone,mode=pload,src=d:\Original.gho,dst=1:1 -fx -sure -rb
```

If you select [**Windows and Application Programs**], the latest backup file (Recent.gho) is restored, skipping the installation and setup of application programs.

For description of relevant parameters, refer to [**Introducing Ghosts Functions**].

For more information about menu design, refer to Config.sys and Autoexec.bat under /Menu in the CD. You can also create a backup CD containing Ghost.exe and these two files.

Recover CD

In recent years, well-known computer manufacturers (such as IBM, Acer, Compaq, etc.) bundle Recover CDs with their computers to reduce the cost resulting from servicing, while at the same time increasing their market competitiveness.

The following is a simple guide to how to create a recover CD:

1. For extremely easy creation of the recover floppy disk, use the copy program for example “Easy CD Creator “ (Note 2). First, create a recover floppy disk containing:

Bootable files (Command.com and Io.sys and MSDOS.SYS)

Config.sys (Configuration setup file)

Autoexec.bat (Auto-execution batch file)

Mscdex.exe (CD-Rom execution file)

Ghost.exe (Ghost execution file)

Oakcdrom.sys (ATAPI CD-ROM compatible driver)

The content of Config.sys is:

```
DEVICE=Oakcdrom.sys /d:idecd001
```

The content of Autoexec.bat includes:

```
MSCDEX.EXE /D:IDECD001 /L:Z
```

```
Ghost.exe clone,mode=load,src=z:\original.gho,dst=1 -sure -rb
```

2. Write the backup image file (original.gho) of the entire hard disk or partition into the recover CD. Use the Recover CD to boot up the system and restore the backup files automatically.

For description of relevant parameters, refer to **[Introducing Ghosts Functions]**.

Note: For more details regarding the creation program and method for creating the recover CD, please refer to the legal software and relevant operation manual.

Ghost Command Line Switches Reference

Ghost may be run in interactive or in batch mode. Batch mode is useful for automating installations for backups using Ghost. Most of the Ghost switches are used to assist with batch mode operation. To list switches from Ghost, type `ghost.exe -h`.

-clone

The full syntax for this switch is:

```
clone,MODE={ copy|load|dump|pcopy|pload|pdump },SRC=
{ drive|file|drive:partition|,DST={ drive|file|drive:partition } ,SIZE{ F|L|n=
{ nnnnM|nnP|F|V }
```

Clone using arguments. This is the most useful of the batch switches and has a series of arguments that define:

- a) **MODE** This defines the type of clone command to be used:
- | | |
|--------------|-----------------------------|
| COPY | disk to disk copy |
| LOAD | file to disk load |
| DUMP | disk to file dump |
| PCOPY | partition to partition copy |
| PLOAD | file to partition load |
| PDUMP | partition to file dump |
- b) **SRC** This defines the source location for the operation:
- | Mode | Meaning: |
|---------------|---|
| COPY/ | |
| DUMP | Source drive (e.g, 1 for drive one) |
| LOAD | Disk image filename or device (e.g, g:\Images\system2.img) |
| PCOPY/ | |
| PDUMP | Source partition e.g, 1:2 indicates the second partition on drive one. |
| PLOAD | Partition image filename or device and partition number. Example: g:\images\disk1.img:2 indicates the second partition in the Image file. |

Appendix

- c) **DST** This defines the destination location for the operation:
- | Mode | Meaning |
|---------------|---|
| COPY/ | |
| LOAD | Destination drive (e.g, 2 for drive two) |
| DUMP | Disk image filename or device,(e.g, g:\images\system2.img) |
| PCOPY/ | |
| PLOAD | Destination partition,(e.g, 2:2 indicates the second partition on drive two). |
| PDUMP | Partition image filename (e.g, g:\images\part1.img). |
- c) **SIZEy** Used to set the size of the destination partitions for either a disk load or disk copy operation.

Available y Options:

- F** Resizes the first partition to maximum size allowed based on file system t type.
- L** Resizes the last partition to maximum size allowed based on file system type.
- n=xxxxM** - indicates that the nth destination partition is to have a size of xxxx Mb. (e.g, **SZE2=800M** indicates partition two is to have 800 mb.)
- n=mmP** - indicates that the nth destination partition is to have a size of mm percent of the target disk.
- n=F** - indicates that the nth destination partition is to remain fixed in size.
- n=V** - Indicates that the partition will be resized according to the following rules:
- Rule 1** - If the destination disk is larger than the original source disk, then the partition(s) will be expanded to have the maximum amount of space subject to the free space available and the partition type (e.g, FAT16 partitions will have a maximum size of 2048Mb.)
- Rule 2** - If the destination disk is smaller than the original source disk, (but still large enough to accommodate the data from the source disk), the free space left over after the

data space has been satisfied will be distributed between the destination partitions in proportion to the data usage in the source partitions. Some examples follow that will help illustrate:

- fx flag Exit. Normally when Ghost has finished copying a new system to a disk, it prompts the user to reboot with a press Ctrl-Alt-Del to reboot window. However, if Ghost is being run as part of a batch file it is sometimes useful to have it just exist back to the DOS prompt after completion so that further batch commands may be processed. -fx enables this. See -rb for another option on completing a clone.
- ia Image All. The Image All switch forces Ghost to do a sector by sector copy of all partitions. When copying a partition from a disk to an image file or to another disk, Ghost examines the source partition and decides whether to copy just the files and directory structure, or to do an image (sector by sector) copy. If it understands the internal format of the partition it defaults to copying the files and directory structure. Generally this is the best option, but occasionally if a disk has been set up with special hidden security files that are in specific positions on the partition, the only way to reproduce them accurately on the target partition is via an image or sector-by-sector copy.
- span enables spanning across volumes.
- split=x splits image file into 'x' Mb? Mb spans. Use this to create a 'forced' size volume set. For example, if you would like to force smaller image files from a 1024 Megabyte drive, you could specify 200 megabyte segments. For example, ghost.exe -split=200 will divide the image into 200 Megabyte segments.
- sure use the -sure switch in conjunction with -clone to avoid being prompted with the final 'Proceed with disk clone destination drive will be overwritten?' question. This command is useful in batch mode.

Appendix

Example 1:

To copy drive one to drive two on a PC, without final prompt if OK to proceed.

```
ghost.exe -clone,mode=copy,src=1,dst=2 -sure
```

Example 2:

To connect via NetBIOS to another PC running Ghost in slave mode, and dump a disk image of local drive two to the remote file c:\drive2.gho

```
ghost.exe -clone,mode=dump,src=2,dst=C:\drive2.gho -nbm
```

Note: The slave Ghost can be started with `ghost -nbs`

Example 3:

To copy drive one, second partition on a PC to drive two, first partition the same PC, without final prompt

```
ghost.exe -clone,mode=pcopy,src=1:2,dst=2:1 -sure
```

Example 4:

To dump the second partition of drive one to an image file on a mapped drive g:

```
ghost.exe -clone,mode=pdump,src=1:2,dst=g:\part2.gho
```

Example 5:

To load partition 2 from a two-partition image file on a mapped drive g: onto the second partition of the local disk

```
ghost -clone,mode=pload,src=g:\part2.gho:2,dst=1:2
```

Example 6:

To load drive 2 from an image file and resize the destination partitions into a 20:40 allocation

```
ghost.exe -clone,mode=load,src=g:\2prtdisk.gho,dst=2,size1=60P,  
size2=40P
```

C-1 EEPROM BIOS Remover

Do not remove the BIOS chip, unless instructed by a technician and only with a PLCC IC extractor tool.

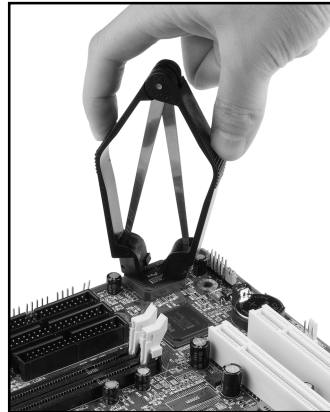
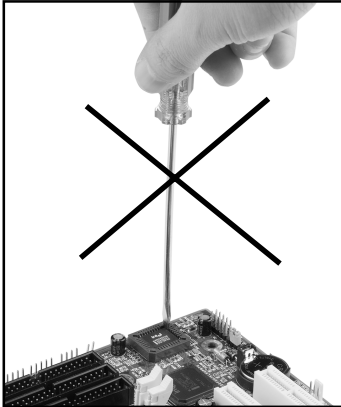

The BIOS socket may be damaged if using an improper method to replace the BIOS chip.

D-1 Update Your System BIOS

Download the xxxxx.EXE file corresponding to your model from our website to an empty directory on your hard disk or floppy. Run the downloaded xxxxx.EXE file and it will self extract. Copy these extracted files to a bootable DOS floppy disk.

Note: The DOS floppy disk should contain NO device drivers or other programs.

1. Type "A:\AWDFLASH and press <Enter> Key.
2. You will see the following setup on screen.
3. Please key in the xxxxx.bin BIOS file name.

```
FLASH MEMORY WRITER V7.88
(C)Award Software 2000 All Rights Reserved

For xxxx-W83627-6A69LPA9C-0  DATE: 05/11/2000
Flash Type -
File Name to Program : _____

Error Message:
```

4. If you want to save the previous BIOS data to the diskette, please key in [Y], otherwise please key in [N].

```
FLASH MEMORY WRITER V7.88
(C)Award Software 2000 All Rights Reserved

For xxxx-W83627-6A69LPA9C-0  DATE: 05/11/2000
Flash Type - xxxxx E82802AB /3.3V
File Name to Program : xxxxx.bin

Error Message: Do You Want To Save Bios (Y/N)
```

Appendix

5. Key in File Name to save previous BIOS to file.

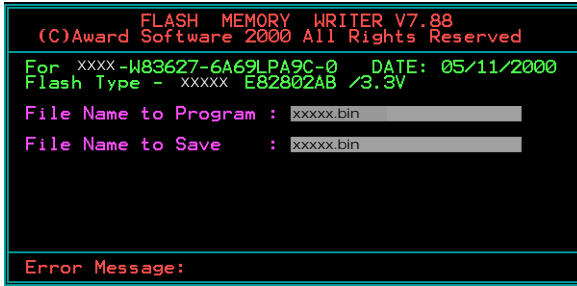

6. Are you sure to program (y/n), please key in [Y] to start the programming.

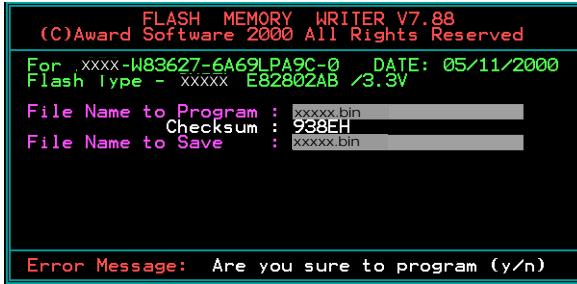

7. The programming is finished.

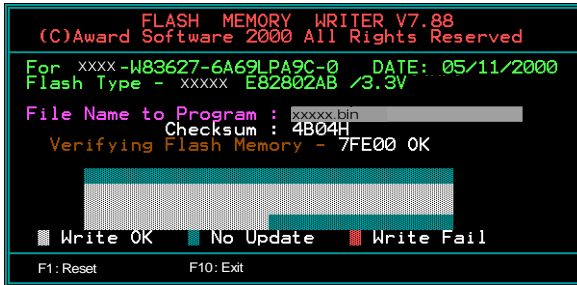

E-1 POST CODES (Optional)

POST (hex)	DESCRIPTION
CfH	Test CMOS R/W functionality.
C0h	Early chipset initialization: <ul style="list-style-type: none">- Disable shadow RAM- Disable L2 cache (socket 7 or below)- Program basic chipset registers
C1h	Detect memory <ul style="list-style-type: none">- Auto-detection of DRAM size, type and ECC.- Auto-detection of L2 cache (socket 7 or below)
C3h	Expand compressed BIOS code to DRAM
C5h	Call chipset hook to copy BIOS back to E000 & F000 shadow RAM.
0h1	Expand the Xgroup codes locating in physical address 1000:0
02h	Reserved
03h	Initial Superio_Early_Init switch.
04h	Reserved
05h	<ol style="list-style-type: none">1. Blank out screen2. Clear CMOS error flag
06h	Reserved
07h	<ol style="list-style-type: none">1. Clear 8042 interface2. Initialize 8042 self-test
08h	<ol style="list-style-type: none">1. Test special keyboard controller for Winbond 977 series Super I/O chips.2. Enable keyboard interface.
09h	Reserved
0Ah	<ol style="list-style-type: none">1. Disable PS/2 mouse interface (optional).2. Auto detect ports for keyboard & mouse followed by a port & interface swap (optional).3. Reset keyboard for Winbond 977 series Super I/O chips.
0B-0Dh	Reserved

Appendix

0Eh	Test F000h segment shadow to see whether it is R/W-able or not. If test fails, keep beeping the speaker.
0Fh	Reserved
10h	Auto detect flash type to load appropriate flash R/W codes into the run time area in F000 for ESCD & DMI support.
11h	Reserved
12h	Use walking 1's algorithm to check out interface in CMOS circuitry. Also set real-time clock power status, and then check for override.
13h	Reserved
14h	Program chipset default values into chipset. Chipset default values are MODBINable by OEM customers.
15h	Reserved
16h	Initial Early_Init_Onboard_Generator switch.
17h	Reserved
18h	Detect CPU information including brand, SMI type (Cyrix or Intel) and CPU level (586 or 686).
19-1Ah	Reserved
1Bh	Initial interrupts vector table. If no special specified, all H/W interrupts are directed to SPURIOUS_INT_HDLR & S/W interrupts to SPURIOUS_soft_HDLR.
1Ch	Reserved
1Dh	Initial EARLY_PM_INIT switch.
1Eh	Reserved
1Fh	Load keyboard matrix (notebook platform)
20h	Reserved
21h	HPM initialization (notebook platform)
22h	Reserved
23h	<ol style="list-style-type: none">1. Check validity of RTC value: e.g. a value of 5Ah is an invalid value for RTC minute.2. Load CMOS settings into BIOS stack. If CMOS checksum fails, use default value instead.3. Prepare BIOS resource map for PCI & PnP use. If ESCD is valid, take into consideration of the ESCD's legacy information.

	4. Onboard clock generator initialization. Disable respective clock resource to empty PCI & DIMM slots.
	5. Early PCI initialization: -Enumerate PCI bus number -Assign memory & I/O resource -Search for a valid VGA device & VGA BIOS, and put it into C000:0.
24-26h	Reserved
27h	Initialize INT 09 buffer
28h	Reserved
29h	1. Program CPU internal MTRR (P6 & PII) for 0-640K memory address. 2. Initialize the APIC for Pentium class CPU. 3. Program early chipset according to CMOS setup. Example: onboard IDE controller. 4. Measure CPU speed. 5. Invoke video BIOS.
2A-2Ch	Reserved
2Dh	1. Initialize multi-language 2. Put information on screen display, including Award title, CPU type, CPU speed
2E-32h	Reserved
33h	Reset keyboard except Winbond 977 series Super I/O chips.
34-3Bh	Reserved
3Ch	Test 8254
3Dh	Reserved
3Eh	Test 8259 interrupt mask bits for channel 1.
3Fh	Reserved
40h	Test 8259 interrupt mask bits for channel 2.
41h	Reserved
42h	Reserved
43h	Test 8259 functionality.
44h	Reserved
45-46h	Reserved
47h	Initialize EISA slot

Appendix

48h	Reserved
49h	<ol style="list-style-type: none">1. Calculate total memory by testing the last double word of each 64K page.2. Program writes allocation for AMD K5 CPU.
4A-4Dh	Reserved
4Eh	<ol style="list-style-type: none">1. Program MTRR of M1 CPU2. Initialize L2 cache for P6 class CPU & program CPU with proper cacheable range.3. Initialize the APIC for P6 class CPU.4. On MP platform, adjust the cacheable range to smaller one in case the cacheable ranges between each CPU are not identical.
4Fh	Reserved
50h	Initialize USB
51h	Reserved
52h	Test all memory (clear all extended memory to 0)
53-54h	Reserved
55h	Display number of processors (multi-processor platform)
56h	Reserved
57h	<ol style="list-style-type: none">1. Display PnP logo2. Early ISA PnP initialization -Assign CSN to every ISA PnP device.
58h	Reserved
59h	Initialize the combined Trend Anti-Virus code.
5Ah	Reserved
5Bh	(Optional Feature) Show message for entering AWDFLASH. EXE from FDD (optional)
5Ch	Reserved
5Dh	<ol style="list-style-type: none">1. Initialize Init_Onboard_Super_IO switch.2. Initialize Init_Onboard_AUDIO switch.
5E-5Fh	Reserved
60h	Okay to enter Setup utility; i.e. not until this POST stage can users enter the CMOS setup utility.
61-64h	Reserved
65h	Initialize PS/2 Mouse

66h	Reserved
67h	Prepare memory size information for function call: INT 15h ax=E820h
68h	Reserved
69h	Turn on L2 cache
6Ah	Reserved
6Bh	Program chipset registers according to items described in Setup & Auto-configuration table.
6Ch	Reserved
6Dh	<ol style="list-style-type: none">1. Assign resources to all ISA PnP devices.2. Auto assign ports to onboard COM ports if the corresponding item in Setup is set to "AUTO".
6Eh	Reserved
6Fh	<ol style="list-style-type: none">1. Initialize floppy controller2. Set up floppy related fields in 40:hardware.
70-72h	Reserved
73h	(Optional Feature) Enter AWDFLASH.EXE if : -AWDFLASH is found in floppy drive. -ALT+F2 is pressed
74h	Reserved
75h	Detect & install all IDE devices: HDD, LS120, ZIP, CDROM.....
76h	Reserved
77h	Detect serial ports & parallel ports.
78h	Reserved
79h	Reserved
7Ah	Detect & install co-processor
7B-7Eh	Reserved
7Fh	<ol style="list-style-type: none">1. Switch back to text mode if full screen logo is supported. -If errors occur, report errors & wait for keys -If no errors occur or F1 key is pressed to continue:<ul style="list-style-type: none">◆ Clear EPA or customization logo.
80h	Reserved
81h	Reserved
82h	<ol style="list-style-type: none">1. Call chipset power management hook.2. Recover the text fond used by EPA logo (not for full

Appendix

	screen logo)
	3. If password is set, ask for password.
83h	Save all data in stack back to CMOS
84h	Initialize ISA PnP boot devices
85h	<ol style="list-style-type: none">1. USB final Initialization2. NET PC: Build SYSID structure3. Switch screen back to text mode4. Set up ACPI table at top of memory.5. Invoke ISA adapter ROMs6. Assign IRQs to PCI devices7. Initialize APM8. Clear noise of IRQs.
86-92h	Reserved
93h	Read HDD boot sector information for Trend Anti-Virus code
94h	<ol style="list-style-type: none">1. Enable L2 cache2. Program boot up speed3. Chipset final initialization.4. Power management final initialization5. Clear screen & display summary table6. Program K6 write allocation7. Program P6 class write combining
95h	<ol style="list-style-type: none">1. Program daylight saving2. Update keyboard LED & typematic rate
96h	<ol style="list-style-type: none">1. Build MP table2. Build & update ESCD3. Set CMOS century to 20h or 19h4. Load CMOS time into DOS timer tick5. Build MSIRQ routing table.
FFh	Boot attempt (INT 19h)

User Notice

No part of this product, including the product and software may be reproduced, transmitted, transcribed, stored in a retrieval system, or translated into any language in any form without the express written permission of EPoX Computer Company (hereinafter referred to as EPoX) except for documentation kept by the purchaser for backup purposes.

We provide this manual “as is” without warranty of any kind, either expressed or implied, including but not limited to the implied warranties or conditions of merchantability or fitness for a particular purpose. In no event shall EPoX be liable for any loss of profits, loss of business, loss of use or data, interruption of business or for indirect, special incidental, or consequential damages of any kind, even if EPoX has been advised of the possibility of such damages arising from any defect or error in the manual or product. EPoX may revise this manual from time to time without notice. For updated BIOS, drivers, or product release information you may visit our websites at <http://www.epox.com> or <http://www.epox.com.tw>.

Products mentioned in this manual are mentioned for identification purposes only. Product names appearing in this manual may or may not be registered trademarks or copyrights of their respective companies. **The product name and revision number are both printed on the mainboard itself.**

Handling Procedures

Static electricity can severely damage your equipment. Handle the EP-4BDA/4BDA2+ and any other device in your system with extreme care and avoid unnecessary contact with system components on the mainboard. Always work on an antistatic surface to avoid possible damage to the mainboard from static discharge. Always have the power supply unplugged and powered off when inserting and removing devices within the computer chassis. EPoX assumes no responsibility for any damage to the EP-4BDA/4BDA2+ mainboard that results from failure to follow instruction or failure to observe safety precautions.



CAUTION



The EP-4BDA/4BDA2+ mainboard is subject to damage by static electricity. Always observe the handling procedures.

Technical Support Services

If you need additional information, help during installation or normal use of this product, please contact your retailer. Your retailer will have the most current information about your configuration. If your retailer cannot help, you may visit our online technical support website and/or contact our support technicians at the locations listed below.

Record your serial number before installing your EP-4BDA/4BDA2+ mainboard. (The serial number is located near the PCI slots at the edge of the board.)

EP-4BDA/4BDA2+ serial number: _____

Contacting Technical Support

EPoX technical support team is working hard to answer all of your questions online. From our website support page you can find answers to many commonly ask questions, drivers updates, latest BIOS release and important technical bulletins that can usually address most issues that users may have. If you are still unable to find a solution to your questions, you can send e-mail to our Technical Support Department nearest you.

<u>Territory</u>	<u>Support e-mail account</u>	<u>Web site</u>
UK & Ireland	technical@epox-uk.com	http://www.epox-uk.com
Germany, Austria and Switzerland	support@elito-epox.com	http://www.elito-epox.com
Netherlands, France, Greece, Poland, Belgium, Spain, Italy, Finland and Other Countries not mentioned above	support@epox.nl	http://www.epox.nl
USA & Canada	support@epox.com	http://www.epox.com
Argentina	tecnica@epoxlatina.com.ar	http://www.epoxlatina.com.ar
Brazil	decio@tecnoworld.com.tw.br	
Korea	korea@epox.com.tw	http://www.epox.com
Australia	australia@epox.com.tw	http://www.epox.com
China (Chinese Simplified)	china@epox.com.tw	http://www.epox.com.cn, http://www.panyuit.com
Taiwan (Chinese Traditional)	fae@epox.com.tw	http://www.epox.com.tw
For Other Countries not mentioned above	support@epox.com.tw	http://www.epox.com

Thank you for using EPoX mainboards!

Copyright 2002 EPoX Computer Company. All rights reserved.
